

PRICE LIST

Effective May, 2018

2018

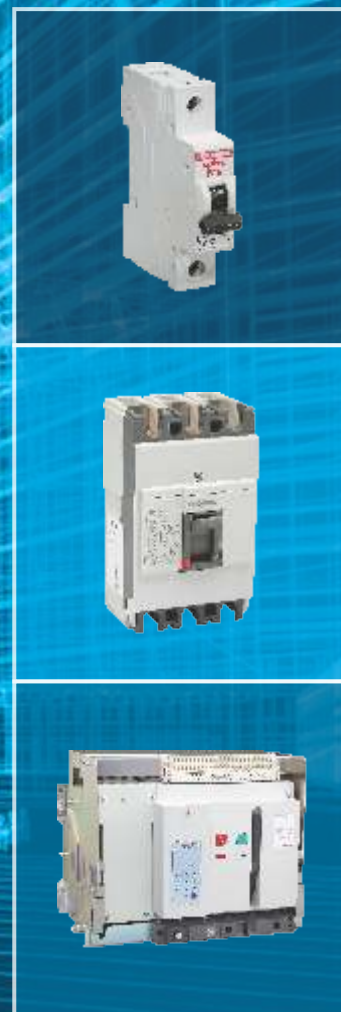

Contents

— optipro —	MINIATURE CIRCUIT BREAKER (MCBs)	01 - 04
— optipro —	AC CIRCUIT BREAKER	05
— optipro —	DC CIRCUIT BREAKER	05 - 06
	GOLDLINE DC MCB	06
— optipro —	ISOLATOR	06
— optipro —	RESIDUAL CURRENT CIRCUIT BREAKER (RCCBs)	08
— optipro —	RCD ADD ON BLOCK	08
— optipro —	ACCESSORIES	08
— optipro —	DISTRIBUTION BOARDS (DBs)	9 - 15
	TIME SWITCHES	16
	TIMELITE DISTRIBUTION BOARDS	17
— optibreak —	AIR CIRCUIT BREAKER	19
— optibreak —	TRIP FREE SWITCH	20
— optibreak —	ACCESSORIES	20 - 22
— optium —	1.0 (FIXED TM RANGE)	24 - 25
— optium —	2.0 (ADJUSTABLE TM RANGE)	25 - 27
— optium —	2.1 & 2.2 (ELECTRONIC RANGE)	27 - 28
— optium —	2.2 (ADJUSTABLE TM RANGE)	28
— optium —	ACCESSORIES	28 - 30
— opticon —	POWER CONTACTORS	32 - 35
— opticon —	MINI CONTACTORS	35
— opticon —	CAPACITOR DUTY CONTACTORS	35
— opticon —	CONTROL RELAY	36
— opticon —	ACCESSORIES FOR CONTACTORS	36 - 37
— opticon —	THERMAL OVERLOAD RELAY	38 - 39
— opticon —	MOTOR PROTECTION CIRCUIT BREAKER - MPCB	39
— opticon —	ACCESSORIES FOR MPCB	39
	SWITCH DISCONNECTOR FUSES	40
	Ambidex CHANGEOVER SWITCHES	41
	HRC FUSE LINKS & BASES	42
	REWIRABLE SWITCH FUSE UNITS	43
	Glint™ WIRING ACCESSORIES	44 - 47
	ELVIRA WIRING ACCESSORIES	48 - 51

—optipro— **MINIATURE CIRCUIT BREAKER - MCB**

- ISI / CE Marked as per IS/IEC 60898 - 1 • Rated Short-Circuit Breaking Capacity, Icn 10kA • Degree of Protection IP 20
- Energy Limitation Class 3 • Line Load Reversibility • 35 sq. mm Terminals • Biconnect Terminals • Frequency: 50 Hz
- Operating Voltage : 240V / 415V AC , 60V DC per pole

B CURVE SINGLE POLE

HSN Code: 8536

	Rating (A)	Pack	Cat. Nos.	Unit Price (₹)
	6	1/12/180	811008	202
10	1/12/180	811010	202	
16	1/12/180	811012	202	
20	1/12/180	811013	202	
25	1/12/180	811014	202	
32	1/12/180	811015	202	
40	1/12/180	811016	446	
50	1/12/180	811017	520	
63	1/12/180	811018	520	

B CURVE SINGLE POLE NEUTRAL

HSN Code: 8536

	Rating (A)	Pack	Cat. Nos.	Unit Price (₹)
	6	1/6/90	811027	612
10	1/6/90	811029	612	
16	1/6/90	811031	612	
20	1/6/90	811032	612	
25	1/6/90	811033	612	
32	1/6/90	811034	612	
40	1/6/90	811035	888	
50	1/6/90	811036	1032	
63	1/6/90	811037	1032	

B CURVE DOUBLE POLE

HSN Code: 8536

	Rating (A)	Pack	Cat. Nos.	Unit Price (₹)
	6	1/6/90	811046	612
10	1/6/90	811048	612	
16	1/6/90	811050	612	
20	1/6/90	811051	612	
25	1/6/90	811052	612	
32	1/6/90	811053	612	
40	1/6/90	811054	888	
50	1/6/90	811055	1032	
63	1/6/90	811056	1032	

C CURVE SINGLE POLE

HSN Code: 8536

	Rating (A)	Pack	Cat. Nos.	Unit Price (₹)
	0.5	1/12/180	811114	342
1	1/12/180	811115	342	
2	1/12/180	811117	342	
3	1/12/180	811119	342	
4	1/12/180	811120	342	
5	1/12/180	811121	342	
6	1/12/180	811122	206	
10	1/12/180	811124	206	
16	1/12/180	811126	206	
20	1/12/180	811127	206	
25	1/12/180	811128	206	
32	1/12/180	811129	206	
40	1/12/180	811130	472	
50	1/12/180	811131	526	
63	1/12/180	811132	526	

—optipro— **MINIATURE CIRCUIT BREAKER - MCB**

C CURVE SINGLE POLE NEUTRAL

HSN Code: 8536

	Rating (A)	Pack	Cat. Nos.	Unit Price (₹)
	0.5	1/6/90	811136	932
1	1/6/90	811137	932	
2	1/6/90	811139	932	
3	1/6/90	811141	932	
4	1/6/90	811142	932	
5	1/6/90	811143	932	
6	1/6/90	811144	622	
10	1/6/90	811146	622	
16	1/6/90	811148	622	
20	1/6/90	811149	622	
25	1/6/90	811150	622	
32	1/6/90	811151	622	
40	1/6/90	811152	922	
50	1/6/90	811153	1050	
63	1/6/90	811154	1050	

C CURVE DOUBLE POLE

HSN Code: 8536

	Rating (A)	Pack	Cat. Nos.	Unit Price (₹)
	0.5	1/6/90	811158	964
1	1/6/90	811159	964	
2	1/6/90	811161	964	
3	1/6/90	811163	964	
4	1/6/90	811164	964	
5	1/6/90	811165	964	
6	1/6/90	811166	688	
10	1/6/90	811168	688	
16	1/6/90	811170	688	
20	1/6/90	811171	688	
25	1/6/90	811172	688	
32	1/6/90	811173	688	
40	1/6/90	811174	1040	
50	1/6/90	811175	1168	
63	1/6/90	811176	1168	

C CURVE THREE POLE

HSN Code: 8536

	Rating (A)	Pack	Cat. Nos.	Unit Price (₹)
	0.5	1/4/60	811180	1326
1	1/4/60	811181	1326	
2	1/4/60	811183	1326	
3	1/4/60	811185	1326	
4	1/4/60	811186	1326	
5	1/4/60	811187	1326	
6	1/4/60	811188	1104	
10	1/4/60	811190	1104	
16	1/4/60	811192	1104	
20	1/4/60	811193	1104	
25	1/4/60	811194	1104	
32	1/4/60	811195	1104	
40	1/4/60	811196	1574	
50	1/4/60	811197	1720	
63	1/4/60	811198	1720	

—optipro— **MINIATURE CIRCUIT BREAKER - MCB**

C CURVE THREE POLE NEUTRAL

HSN Code: 8536



Rating (A)	Pack	Cat. Nos.	Unit Price (₹)
0.5	1/3/45	811202	1716
1	1/3/45	811203	1716
2	1/3/45	811205	1716
3	1/3/45	811207	1716
4	1/3/45	811208	1716
5	1/3/45	811209	1716
6	1/3/45	811210	1398
10	1/3/45	811212	1398
16	1/3/45	811214	1398
20	1/3/45	811215	1398
25	1/3/45	811216	1398
32	1/3/45	811217	1398
40	1/3/45	811218	1874
50	1/3/45	811219	1946
63	1/3/45	811220	1946

C CURVE FOUR POLE

HSN Code: 8536



Rating (A)	Pack	Cat. Nos.	Unit Price (₹)
0.5	1/3/45	811224	1846
1	1/3/45	811225	1846
2	1/3/45	811227	1846
3	1/3/45	811229	1846
4	1/3/45	811230	1846
5	1/3/45	811231	1846
6	1/3/45	811232	1540
10	1/3/45	811234	1540
16	1/3/45	811236	1540
20	1/3/45	811237	1540
25	1/3/45	811238	1540
32	1/3/45	811239	1540
40	1/3/45	811240	2042
50	1/3/45	811241	2200
63	1/3/45	811242	2200

D CURVE SINGLE POLE

HSN Code: 8536



Rating (A)	Pack	Cat. Nos.	Unit Price (₹)
0.5	1/12/180	811246	386
1	1/12/180	811247	386
2	1/12/180	811249	386
3	1/12/180	811251	386
4	1/12/180	811252	386
5	1/12/180	811253	386
6	1/12/180	811254	314
10	1/12/180	811256	314
16	1/12/180	811258	314
20	1/12/180	811259	314
25	1/12/180	811260	314
32	1/12/180	811261	314
40	1/12/180	811262	550
50	1/12/180	811263	626
63	1/12/180	811264	626

—optipro— **MINIATURE CIRCUIT BREAKER - MCB**

D CURVE DOUBLE POLE

HSN Code: 8536

	Rating (A)	Pack	Cat. Nos.	Unit Price (₹)
	0.5	1/6/90	811284	994
1	1/6/90	811285	994	
2	1/6/90	811287	994	
3	1/6/90	811289	994	
4	1/6/90	811290	994	
5	1/6/90	811291	994	
6	1/6/90	811292	796	
10	1/6/90	811294	796	
16	1/6/90	811296	796	
20	1/6/90	811297	796	
25	1/6/90	811298	796	
32	1/6/90	811299	796	
40	1/6/90	811300	1152	
50	1/6/90	811301	1216	
63	1/6/90	811302	1216	

D CURVE THREE POLE

HSN Code: 8536

	Rating (A)	Pack	Cat. Nos.	Unit Price (₹)
	0.5	1/4/60	811303	1428
1	1/4/60	811304	1428	
2	1/4/60	811306	1428	
3	1/4/60	811308	1428	
4	1/4/60	811309	1428	
5	1/4/60	811310	1428	
6	1/4/60	811311	1152	
10	1/4/60	811313	1152	
16	1/4/60	811315	1152	
20	1/4/60	811316	1152	
25	1/4/60	811317	1152	
32	1/4/60	811318	1152	
40	1/4/60	811319	1754	
50	1/4/60	811320	1852	
63	1/4/60	811321	1852	

D CURVE FOUR POLE

HSN Code: 8536

	Rating (A)	Pack	Cat. Nos.	Unit Price (₹)
	0.5	1/3/45	811341	1834
1	1/3/45	811342	1834	
2	1/3/45	811344	1834	
3	1/3/45	811346	1834	
4	1/3/45	811347	1834	
5	1/3/45	811348	1834	
6	1/3/45	811349	1530	
10	1/3/45	811351	1530	
16	1/3/45	811353	1530	
20	1/3/45	811354	1530	
25	1/3/45	811355	1530	
32	1/3/45	811356	1530	
40	1/3/45	811357	2154	
50	1/3/45	811358	2344	
63	1/3/45	811359	2344	

—optipro— **AC CIRCUIT BREAKER**

- Conforms to IEC 60947 - 2 • CE Marked • Rated Short-Circuit Capacity, Icu 10kA • Degree of Protection IP 20
- 1.5 Module per pole • 50 sq. mm Terminals • Frequency: 50 Hz • Operating Voltage: 240V/415V AC, 60V DC per Pole

SINGLE POLE

HSN Code: 8536

	Rating (A)	Pack	Cat. Nos.	Unit Price (₹)
	80	1	811133	1938
	100	1	811134	2148
	125	1	811135	2394

DOUBLE POLE

HSN Code: 8536

	Rating (A)	Pack	Cat. Nos.	Unit Price (₹)
	80	1	811177	4414
	100	1	811178	4748
	125	1	811179	5204

THREE POLE

HSN Code: 8536

	Rating (A)	Pack	Cat. Nos.	Unit Price (₹)
	80	1	811199	6690
	100	1	811200	7282
	125	1	811201	7912

FOUR POLE

HSN Code: 8536

	Rating (A)	Pack	Cat. Nos.	Unit Price (₹)
	80	1	811243	8662
	100	1	811244	8946
	125	1	811245	10170

—optipro— **DC CIRCUIT BREAKER**

- Conforms to IEC 60947 - 2 • CE Marked • Breaking Capacity 6kA • Degree of Protection IP 20 • 35 sq. mm Terminals
- Biconnect Terminals • Upto 250V Supply

SINGLE POLE

HSN Code: 8536

	Rating (A)	Pack	Cat. Nos.	Unit Price (₹)
	0.5	1/12/180	811400	410
	1	1/12/180	811401	410
	2	1/12/180	811403	410
	3	1/12/180	811405	410
	4	1/12/180	811406	410
	5	1/12/180	811407	410
	6	1/12/180	811408	364
	10	1/12/180	811410	364
	16	1/12/180	811412	364
	20	1/12/180	811413	364
	25	1/12/180	811414	364
	32	1/12/180	811415	364
	40	1/12/180	811416	506
	50	1/12/180	811417	574
	63	1/12/180	811418	574

—optipro— DC CIRCUIT BREAKER

DOUBLE POLE

HSN Code: 8536

	Rating (A)	Pack	Cat. Nos.	Unit Price (₹)
	0.5	1/6/90	811419	960
1	1/6/90	811420	960	
2	1/6/90	811422	960	
3	1/6/90	811424	960	
4	1/6/90	811425	960	
5	1/6/90	811426	960	
6	1/6/90	811427	752	
10	1/6/90	811429	752	
16	1/6/90	811431	752	
20	1/6/90	811432	752	
25	1/6/90	811433	752	
32	1/6/90	811434	752	
40	1/6/90	811435	1048	
50	1/6/90	811436	1216	
63	1/6/90	811437	1216	

GOLDLINE DC SERIES MINIATURE CIRCUIT BREAKERS (MCBs)

HSN Code: 8536

	Goldline MCBs DC-6R Suitable for Rail Coaches & Locomotives. Specification No. SPEC/E-12/1/04.	Rating	SP (Unit Price ₹)	DP
		2.5, 5A	456	-
6, 10, 16, 20, 25, 32A	430	-		
40A	584	-		

Unit Price (₹)

—optipro— ISOLATOR

- Conforms to IEC 60947-3 • CE Marked • Degree of Protection IP 20 • 35 sq. mm Terminals • Biconnect Terminals
- Frequency: 50 Hz • Operating Voltage: 240V/415V AC, 60V DC per Pole

DOUBLE POLE

HSN Code: 8536

	Rating (A)	Pack	Cat. Nos.	Unit Price (₹)
	40	1/6/90	811550	434
63	1/6/90	811551	536	
80	1/6/90	811552	692	
100	1/6/90	811553	692	
125	1/6/90	811554	746	

THREE POLE

HSN Code: 8536

	Rating (A)	Pack	Cat. Nos.	Unit Price (₹)
	40	1/4/60	811555	814
63	1/4/60	811556	932	
80	1/4/60	811557	1048	
100	1/4/60	811558	1048	
125	1/4/60	811559	1150	

FOUR POLE

HSN Code: 8536

	Rating (A)	Pack	Cat. Nos.	Unit Price (₹)
	40	1/3/45	811560	972
63	1/3/45	811561	1048	
80	1/3/45	811562	1302	
100	1/3/45	811563	1302	
125	1/3/45	811564	1410	

RCD Add On Block

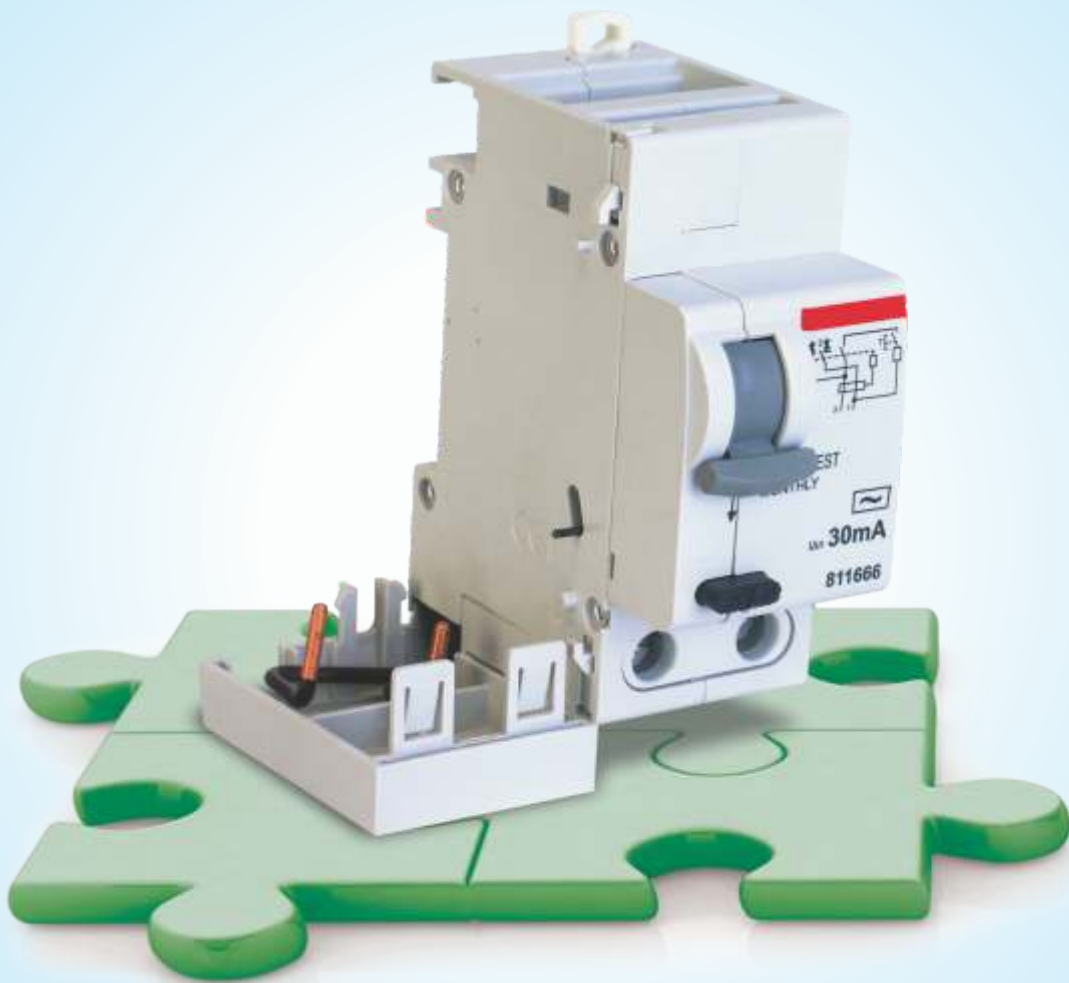

Features:

- Range: 06A to 63A in 30mA/100A/300mA Sensitivity
- Conforms to IEC 60947-2
- Degree of Protection IP 20
- Rated Conditional Short-Circuit Current, I_{cc} 10kA
- 35 sq. mm Terminals
- Dual Position DIN Clip

—optipro— **RESIDUAL CURRENT CIRCUIT BREAKER - RCCB**

- ISI/CE Marked as per IS/IEC 12640 - 1 • Degree of Protection IP 20 • Rated Conditional Short-Circuit Current, Inc 10kA
- 35 sq. mm Terminals • Biconnect Terminals • Frequency: 50 Hz • Operating Voltage: 240V/415V AC

DOUBLE POLE

HSN Code: 8536

	Rating (A)	Sensitivity (mA)	Pack	Cat. Nos.	Unit Price (₹)
	25	30	30	1/6/90	811700
100		100	1/6/90	811706	2590
300		300	1/6/90	811712	2698
40	30	30	1/6/90	811701	2662
	100	100	1/6/90	811707	2662
	300	300	1/6/90	811713	2900
63	30	30	1/6/90	811702	3560
	100	100	1/6/90	811708	3560
	300	300	1/6/90	811714	3636

FOUR POLE

HSN Code: 8536

	Rating (A)	Sensitivity (mA)	Pack	Cat. Nos.	Unit Price (₹)
	25	30	30	1/3/45	811718
100		100	1/3/45	811724	3322
300		300	1/3/45	811730	3452
40	30	30	1/3/45	811719	3406
	100	100	1/3/45	811725	3406
	300	300	1/3/45	811731	3598
63	30	30	1/3/45	811720	3690
	100	100	1/3/45	811726	3690
	300	300	1/3/45	811732	3754

—optipro— **RCD ADD ON BLOCK**

- Conforms to IEC 60947-2 • Degree of Protection IP 20
- Rated Conditional Short-Circuit Current, Icc 10kA • 35 sq. mm Terminals • Dual Position DIN Clip

DOUBLE POLE

HSN Code: 8536

	Rating (A)	Sensitivity (mA)	Pack	Cat. Nos.	Unit Price (₹)
	6A - 32A	30	30	1/ - /32	811666
100		100	1/ - /32	811668	3026
300		300	1/ - /32	811670	2812
40A & 63A	30	30	1/ - /32	811667	3026
	100	100	1/ - /32	811669	3324
	300	300	1/ - /32	811671	3628

FOUR POLE

HSN Code: 8536

	Rating (A)	Sensitivity (mA)	Pack	Cat. Nos.	Unit Price (₹)
	6A - 32A	30	30	1/ - /16	811672
100		100	1/ - /16	811674	3192
300		300	1/ - /16	811676	3330
40A & 63A	30	30	1/ - /16	811673	3424
	100	100	1/ - /16	811675	3724
	300	300	1/ - /16	811677	4018

—optipro— **ACCESSORIES**

HSN Code: 8538

- Conforms to IEC 60947 - 5 - 1 • Retro Fit Type Clip On Accessory • CE Marked
- Upto Three Number of Accessory on a Modular Device • Common Accessories for Entire Range • Easy To Install

	Item Description	Pack	Cat. Nos.	Unit Price (₹)
	Auxiliary Changeover Switch 1NO	1	811580	692
Fault Signalling Contact 1NC	1	811581	790	
Shunt Trip 12V to 48V AC/DC	1	811582	1332	
Shunt Trip 110V to 415V AC	1	811583	1332	
Undervoltage 24V & 48V AC/DC	1	811584	1164	
Undervoltage 240V AC	1	811585	1164	

— optipro™ — **DISTRIBUTION BOARDS (DBs)**

SPN DB-SINGLE DOOR

HSN Code: 8537

- IP : 30 Protection
- Door Earthing
- Isolated Neutral Bar
- Mechanical Impact Strength IK 08
- Cement Spill Protector

	Ways	Modules	Cat Ref.	Unit Price (₹)
	4	4	811800	816
	6	6	811801	1002
	8	8	811802	1042
	12	12	811803	1254
	16	16	811804	1578

SPN DB-DOUBLE DOOR

HSN Code: 8537

- IP : 43 Protection
- Door Earthing
- Isolated Neutral Bar
- Mechanical Impact Strength IK 08
- Cement Spill Protector

	Ways	Modules	Cat Ref.	Unit Price (₹)
	4	4	811805	1190
	6	6	811806	1454
	8	8	811807	1556
	12	12	811808	2006
	16	16	811809	2482

SPN DB -DOUBLE DOOR

HSN Code: 8537

- IP : 54 Protection
- Door Earthing
- Isolated Neutral Bar
- Mechanical Impact Strength IK 09
- Cement Spill Protector

	Ways	Modules	Cat Ref.	Unit Price (₹)
	4	4	811824	1830
	6	6	811825	2236
	8	8	811826	2394
	12	12	811828	3084
	16	16	811829	3818

SPN DB-ACRYLIC DOOR

HSN Code: 8537

- IP : 43 Protection
- Door Earthing
- Isolated Neutral Bar
- Cement Spill Protector

	Ways	Modules	Cat Ref.	Unit Price (₹)
	4	4	811816	1370
	6	6	811817	1674
	8	8	811818	1786
	12	12	811819	2306
	16	16	811820	2854

— optipro™ — **DISTRIBUTION BOARDS (DBs)**

TPN DB-SINGLE DOOR

HSN Code: 8537

- IP : 30 Protection
- Door Earthing
- Isolated Neutral Bar
- Mechanical Impact Strength IK 08
- Cement Spill Protector

	Ways	Modules	Cat Ref.	Unit Price (₹)
	4 Way compact	4 + 12	811832	2154
	4 Way	8 + 12	811833	2382
	6 Way compact	4 + 18	811834	2802
	6 Way	8 + 18	811835	3110
	8 Way	8 + 24	811836	3710
	12 Way	8 + 36	811837	5138

TPN DB-DOUBLE DOOR

HSN Code: 8537

- IP : 43 Protection
- Door Earthing
- Isolated Neutral Bar
- Mechanical Impact Strength IK 08
- Cement Spill Protector

	Ways	Modules	Cat Ref.	Unit Price (₹)
	4 Way compact	4 + 12	811840	2910
	4 Way	8 + 12	811841	3294
	6 Way compact	4 + 18	811842	3774
	6 Way	8 + 18	811843	4118
	8 Way	8 + 24	811844	5114
	12 Way	8 + 36	811845	7268
	16 Way	8 + 48	811846	8772

TPN DB -DOUBLE DOOR

HSN Code: 8537

- IP : 54 Protection
- Door Earthing
- Isolated Neutral Bar
- Mechanical Impact Strength IK 09
- Cement Spill Protector

	Ways	Modules	Cat Ref.	Unit Price (₹)
	4	4	811856	4476
	4	6	811857	5068
	6	6	811858	5804
	6	6	811859	6336
	8	8	811860	7868
	12	12	811861	11180

TPN DB-ACRYLIC DOOR

HSN Code: 8537

- IP : 43 Protection
- Door Earthing
- Isolated Neutral Bar
- Cement Spill Protector

	Ways	Modules	Cat Ref.	Unit Price (₹)
	4 Way compact	4 + 12	811848	3448
	4 Way	8 + 12	811849	3788
	6 Way compact	4 + 18	811850	4418
	6 Way	8 + 18	811851	4736
	8 Way	8 + 24	811852	5830
	12 Way	8 + 36	811853	8358
	16 Way	8 + 48	811854	10086

— optipro™ — **DISTRIBUTION BOARDS (DBs)**

VTPN MCB DB-SINGLE DOOR

HSN Code: 8537

- IP : 30 Protection
- Door Earthing
- Isolated Neutral Bar
- Mechanical Impact Strength IK 08
- Insulated busbar assembly

	Ways	Modules	Cat Ref.	Unit Price (₹)
	4 Way	8 + 12	811864	7116
	6 Way	8 + 18	811865	8518
	8 Way	8 + 24	811866	8946
	12 Way	8 + 36	811867	11246

VTPN MCB DB-DOUBLE DOOR

- IP : 43 Protection
- Door Earthing
- Isolated Neutral Bar
- Mechanical Impact Strength IK 08
- Insulated busbar assembly

	Ways	Modules	Cat Ref.	Unit Price (₹)
	4 Way	8 + 12	811870	8370
	6 Way	8 + 18	811871	10024
	8 Way	8 + 24	811872	10524
	12 Way	8 + 36	811873	13230

VTPN DB -DOUBLE DOOR

HSN Code: 8537

- IP : 54 Protection
- Door Earthing
- Isolated Neutral Bar
- Mechanical Impact Strength IK 09
- Cement Spill Protector

	Ways	Modules	Cat Ref.	Unit Price (₹)
	4	4	811882	12876
	6	6	811883	15420
	8	8	811884	16192
	12	12	811885	20356

VTPN MCCB 125A DB-DOUBLE DOOR

HSN Code: 8537

- IP : 43 Protection
- Door Earthing
- Isolated Neutral Bar
- Mechanical Impact Strength IK 08
- Insulated busbar assembly
- Suitable for MCCB's upto 125A as I/C (Frame1)

	Ways	Modules	Cat Ref.	Unit Price (₹)
	4 Way	Optium F1 + 12	811888	9522
	6 Way	Optium F1 + 18	811889	10774
	8 Way	Optium F1 + 24	811890	11528
	12 Way	Optium F1 + 36	811891	15536

VTPN MCCB 125A DB -DOUBLE DOOR

HSN Code: 8537

- IP : 54 Protection
- Door Earthing
- Isolated Neutral Bar
- Mechanical Impact Strength IK 09
- Cement Spill Protector
- Suitable for MCCB's upto 125A as I/C (Frame1)

	Ways	Modules	Cat Ref.	Unit Price (₹)
	4	4	812040	14650
	6	6	812041	16576
	8	8	812042	17734
	12	12	812043	23900

— optipro™ — **DISTRIBUTION BOARDS (DBs)**

VTPN MCCB 250A DB-DOUBLE DOOR

HSN Code: 8537

- IP : 43 Protection
- Door Earthing
- Isolated Neutral Bar
- Mechanical Impact Strength IK 08
- Insulated busbar assembly
- Suitable for MCCB's upto 250A as I/C (Frame 2)

	Ways	Modules	Cat Ref.	Unit Price (₹)
	4 Way	Optium F2+ 12	811893	16038
	6 Way	Optium F2+ 18	811894	16790
	8 Way	Optium F2+ 24	811895	19672
	12 Way	Optium F2+ 36	811896	21050

VTPN MCCB 250A DB -DOUBLE DOOR

HSN Code: 8537

- IP : 54 Protection
- Door Earthing
- Isolated Neutral Bar
- Mechanical Impact Strength IK 09
- Cement Spill Protector
- Suitable for MCCB's upto 250A as I/C (Frame 2)

	Ways	Modules	Cat Ref.	Unit Price (₹)
	4	4	812045	24676
	6	6	812046	25830
	8	8	812047	30266
	12	12	812048	32384

FLEXI DB-DOUBLE DOOR

HSN Code: 8537

- IP : 43 Protection
- Door Earthing
- Isolated Neutral Bar
- Mechanical Impact Strength IK 08
- Cement Spill Protector

	Ways	Modules	Cat Ref.	Unit Price (₹)
	14 X 2 Row	28	811912	4510
	14 X 3 Row	42	811913	5362
	14 X 4 Row	56	811915	5966

FLEXI DB -DOUBLE DOOR

HSN Code: 8537

- IP : 54 Protection
- Door Earthing
- Isolated Neutral Bar
- Mechanical Impact Strength IK 09
- Cement Spill Protector

	Ways	Modules	Cat Ref.	Unit Price (₹)
	14 X 2 Row	28	812030	6938
	14 X 2 Row	42	812031	8250
	14 X 2 Row	56	812033	9178

— optipro™ — DISTRIBUTION BOARDS (DBs)

7 SEGMENT DB-DOUBLE DOOR

HSN Code: 8537

- IP : 43 Protection
- Door Earthing
- Isolated Neutral Bar
- Mechanical Impact Strength IK 08
- Compartmentalized solution



Ways	Modules	Cat Ref.	Unit Price (₹)
4 Way	8 + 12 + 12	811925	7718
6 Way	8 + 12 + 18	811926	8724
8 Way	8 + 12 + 24	811927	10024
12 Way	8 + 12 + 36	811928	12530

PHASE SELECTOR DB 40A DOUBLE DOOR

HSN Code: 8537

- IP : 43 Protection
- Door Earthing
- 40 A prefitted selector switch
- Mechanical Impact Strength IK 08
- Isolated Neutral Bar



Ways	Modules	Cat Ref.	Unit Price (₹)
4 Way	4 + 12	811940	9140
6 Way	4 + 18	811941	9524
8 Way	8 + 24	811942	10342
12 Way	8 + 36	811943	11646

PHASE SELECTOR DB 63A DOUBLE DOOR

HSN Code: 8537

- IP : 43 Protection
- Door Earthing
- 63 A prefitted selector switch
- Mechanical Impact Strength IK 08
- Isolated Neutral Bar



Ways	Modules	Cat Ref.	Unit Price (₹)
4 Way	4 + 12	811950	10740
6 Way	4 + 18	811951	11204
8 Way	8 + 24	811952	12168
12 Way	8 + 36	811953	13700

METAL CLAD P&S

HSN Code: 8537

- IP : 30 Protection
- Without MCBs
- Mechanical Impact Strength IK 08



Ways	Modules	Cat Ref.	Unit Price (₹)
20A 2P + E	1 Mod	811955	902
20A 2P + E	2 Mod	811956	902
20A 3P + E	3 Mod	811957	2006
32A 3P + E	3 Mod	811958	2858

— optipro™ — DISTRIBUTION BOARDS (DBs)

TV/TEL DB

HSN Code: 8537

- IP : 43 Protection
- Door Earthing
- Factory fitted KRONE type TV & TEL socket
- Mechanical Impact Strength IK 08
- Isolated & Shrouded Neutral Bar

	Ways	Modules	Cat Ref.	Unit Price (₹)
	8 Way SPN	8	811963	3774
12 Way SPN	12	811964	4256	
4 Way TPN	8+12	811967	6034	
6 Way TPN	8+18	811983	6412	
8 Way TPN	8+24	811968	7112	

PPI DB

HSN Code: 8537

- IP : 43 Protection
- Door Earthing
- Isolated Neutral Bar for individual phase
- Mechanical Impact Strength IK 08
- Cement Spill Protector

	Ways	Modules	Cat Ref.	Unit Price (₹)
	Hori 4+2 Way	8+6+12	811971	6316
Hori 6+2 Way	8+6+18	811972	7746	
Hori 8+2 Way	8+6+24	811973	9174	
Tier 6+2 Way	8+6+18	811974	7112	
Tier 8+2 Way	8+6+24	811975	8796	
Tier 12+2 Way	8+6+36	811976	10334	

PPI DB - DOUBLE DOOR

HSN Code: 8537

- IP :54 Protection
- Door Earthing
- Isolated Neutral Bar
- Mechanical Impact Strength IK 09
- Cement Spill Protector

	Ways	Modules	Cat Ref.	Unit Price (₹)
	4	2	812034	9718
6	2	812035	11916	
8	2	812036	14116	
6	2	812037	10940	
8	2	812038	13532	
12	2	812039	15898	

PLASTIC P&S

HSN Code: 8537

- IP : 30 Protection
- Without MCBs

	Ways	Modules	Cat Ref.	Unit Price (₹)
	16A 2P+E	2 Mod	811959	2390
32A 2P+E	2 Mod	811960	3550	
32A 3P+N+E	4 Mod	811961	3908	
63A 3P+N+E	4 Mod	811962	10802	

— optipro™ — DISTRIBUTION BOARDS (DBs)

ENCLOSURES

HSN Code: 8537

	Ways	Modules	Cat Ref.	Unit Price (₹)
	1/2 Mod plastic	2	811977	138
	3/4 Mod plastic	4	811978	214
	1 Mod metal	1	811979	302
	2 Mod metal	2	811980	302
	3 Mod metal	3	811981	402
	4 Mod metal	4	811982	402

CABLE END BOX

HSN Code: 8537

• IP : 43 Protection

• Mechanical Impact Strength IK08

Description	Cat Ref.	Unit Price (₹)
SPN DD 4 Way DB	812000	542
SPN DD 6 Way DB	812001	600
SPN DD 8 Way DB	812002	636
SPN DD 12 Way DB	812004	748
SPN DD 16 Way DB	812005	890
TPN DD 4 Way 4 Pole I/c DB	812006	684
TPN DD 4 Way 8 Pole I/c DB	812007	824
TPN DD 6 Way 4 Pole I/c DB	812008	898
TPN DD 6 Way 8 Pole I/c DB	812009	974
TPN DD 8 Way DB	812010	1200
TPN DD 12 Way DB	812012	1640
TPN DD 16 Way DB	812013	1686
VTPN MCB I/c DB	812014	1312
Flexy DD 14x2 Way DB	812016	880
PPI Horizontal DD DB 4+2W	812017	824
PPI Horizontal DD DB 6+2W	812018	974
PPI Horizontal DD DB 8+2W	812019	1200
PPI Tier DD DB 6+2W	812020	974
PPI Tier DD DB 8+2W	812021	1200
PPI Tier DD DB 12+2W	812022	1640
VTPN MCCB I/C DD DB	812023	1312

MCCB ENCLOSURE

• Solid Neutral Link for 3 Pole MCCBs

	Description	Cat Ref.	Unit Price (₹)
	Optipro Enclosure for Frame-1 Optium 3 Pole MCCB	811984	1218
	Optipro Enclosure for Frame-1 Optium 4 Pole MCCB	811985	1218
	Optipro Enclosure for Frame-2 Optium 3 Pole MCCB	811986	1874
	Optipro Enclosure for Frame-2 Optium 4 Pole MCCB	811987	1874
	Optipro Enclosure for Frame-3 Optium 3 Pole MCCB	811988	1874
	Optipro Enclosure for Frame-3 Optium 4 Pole MCCB	811989	1874
	Optipro Enclosure for Frame-4 Optium 3 Pole MCCB	811990	4684
	Optipro Enclosure for Frame-4 Optium 4 Pole MCCB	811991	4684

**METAL CLAD PLUG & SOCKET
AC PLUG**

HSN Code: 8536

	Rating	Pack	Cat. Nos.	Unit Price (₹)
	10A 2P+E, 230V AC	1/10/100	810385	136
	20A 2P+E, 230V AC	1/10/100	810386	146
	20A 3P+E, 230V / 415V AC	1/10/100	810387	200
	32A 3P+E, 230V / 415V AC	1/10/100	810388	362

AC SOCKET

HSN Code: 8536

	Rating	Pack	Cat. Nos.	Unit Price (₹)
	10A 2P+E, 230V AC	1/10/100	810389	136
	20A 2P+E, 230V AC	1/10/100	810390	158
	20A 3P+E, 230V / 415V AC	1/10/100	810391	210
	32A 3P+E, 230V / 415V AC	1/10/100	810392	362

TIME SWITCHES

ANALOG TIME SWITCHES (with battery back up)

HSN Code: 9107

	Model Name	Description	Cat Ref.	Unit Price (₹)
	1mod DIN Daily	1P Module, 24 hours program, Programmable every 15 min., backup of 100 hours, current capacity 16A, with 1 changeover (1 CO)	TA916422	2726
	3mod DIN Daily	3P Module, 24 hours program, Programmable every 15 min., backup of 100 hrs., current capacity 16A, with 1 changeover (1 CO)	TA926453	2970
	Front Mounted Daily	Front Mounting, 24 hours program, Programmable every 20 min., back up of 100 hrs., current capacity 16A, with 1 changeover (1 CO)	TA912472	2726
	3mod DIN Weekly	Weekly program, Programmable every 4 hrs., with back up of 100 hrs., current capacity 16A, with 1 changeover (1 CO)	TA926129	3246

ANALOG TIME SWITCHES (without battery back up)

HSN Code: 9107

	Model Name	Description	Cat Ref.	Unit Price (₹)
	3mod DIN Daily	3P Module, 24 hours program, Programmable every 15 min., current capacity 16A, with 1 changeover (1 CO)	TA925450	2504
	Front Mounted Daily	Front Mounting, 24 hours program, Programmable every 20 min., current capacity 16A, with 1 changeover (1 CO)	TA912473	2256

DIGITAL TIME SWITCHES

HSN Code: 9107

	Model Name	Description	Cat Ref.	Unit Price (₹)
	DIN Type Daily / Weekly with 1 CO	Programmable every 1 min., with backup of 6 years, 28 memory locations, current capacity 16A, weekly program, with 1 changeover (1 CO), Total 28 programs	TDA43110	3612
	DIN Type Daily / Weekly with 2 CO	Programmable every 1 min., with backup of 6 years, 28 memory locations, current capacity 16A, weekly program, with 2 changeover (2 CO), Total 14 programs per channel	TDA43111	5418
	DIN Type Astronomical with 1 CO	Astronomical Programmable every 1 min., backup of 6 years, 28 memory locations, current capacity 16A, with 1 changeover (1 CO), Total 28 programs	TDA45163	7512
DIN Type Astronomical with 2 CO	Astronomical Programmable every 1 min., backup of 6 years, 28 memory locations, current capacity 16A, with 2 changeover (2 CO), Total 14 programs per channel	TDA45193	9390	

LIGHT SENSITIVE SWITCHES

HSN Code: 9107

	Model Name	Description	Cat Ref.	Unit Price (₹)
	1mod DIN Light Sensitive	Light sensitive switch with outer sensor, sensitive distance 50m, current capacity 16A & control from 1 lux to 100K lux.	TSA58107	6262

TIMELITE DISTRIBUTION BOARDS

HSN Code: 8537

	Description	Cat Ref.	Unit Price (₹)
	Timelite-16A 3Pole/230V-Analog Time switch	TL016AB0	17610
	Timelite-32A 3Pole/230V-Analog Time switch	TL032AB0	19052
	Timelite-32A 3Pole/230V-Digital Time Switch	TL032DB0	20792
	Timelite-32A 3Pole/230V-Astronomical Time Switch	TL032AS0	24262
	Timelite-40A 3Pole/230V-Analog Time Switch	TL040AB0	20520
	Timelite-40A 3Pole/230V-Digital Time Switch	TL040DB0	22224
	Timelite-40A 3Pole/230V-Astronomical Time Switch	TL040AS0	25700
	Timelite-65A 3Pole/230V-Analog Time Switch	TL065AB0	26270
	Timelite-65A 3Pole/230V-Digital Time Switch	TL065DB0	28006
	Timelite-65A 3Pole/230V-Astronomical Time Switch	TL065AS0	31462
	Timelite-110A 3Pole/230V-Analog Time Switch	TL110AB0	43978
	Timelite-110A 3Pole/230V-Digital Time Switch	TL110DB0	45316
	Timelite-110A 3Pole/230V-Astronomical Time Switch	TL110AS0	49242
	The analog time switch which will be used in Timelite DBs is TA926453 The digital time switch which will be used in Timelite DBs is TDA43110 The astronomical time switch which will be used in Timelite DBs is TDA45163		

SOME APPLICATIONS OF TIME SWITCHES



Street Lights



Fountain Control



Pump Control



Park Illumination



Control of School Bells / Factory Siren



ATM Illumination



Shop Illumination



Climate Control



Industrial Illumination

**FOR A JOB
WELL DONE, HERE IS
ALL THAT YOU NEED.**

OptiPower



— optibreak™ —

ALL THAT YOU NEED

— optibreak™ — AIR CIRCUIT BREAKER (WITH MICRO PROCESSOR RELEASE)

HSN Code: 8536



Type	Breaking capacity	Frame	Rating	3P	MRP	4P	Unit Price (₹)
Fixed	50kA	B1	630	820001	P.O.R.	820011	P.O.R.
Fixed	50kA	B1	800	820002	P.O.R.	820012	P.O.R.
Fixed	50kA	B1	1000	820003	P.O.R.	820013	P.O.R.
Fixed	50kA	B1	1250	820004	P.O.R.	820014	P.O.R.
Fixed	50kA	B1	1600	820005	P.O.R.	820015	P.O.R.
Fixed	50kA	B1	2000	820006	P.O.R.	820016	P.O.R.
Fixed	50kA	B2	2500	820007	P.O.R.	820017	P.O.R.

HSN Code: 8536



Type	Breaking capacity	Frame	Rating	3P	MRP	4P	Unit Price (₹)
D/O	50kA	B1	630	820101	P.O.R.	820111	P.O.R.
D/O	50kA	B1	800	820102	P.O.R.	820112	P.O.R.
D/O	50kA	B1	1000	820103	P.O.R.	820113	P.O.R.
D/O	50kA	B1	1250	820104	P.O.R.	820114	P.O.R.
D/O	50kA	B1	1600	820105	P.O.R.	820115	P.O.R.
D/O	50kA	B1	2000	820106	P.O.R.	820116	P.O.R.
D/O	50kA	B2	2500	820107	P.O.R.	820117	P.O.R.

HSN Code: 8536



Type	Breaking capacity	Frame	Rating	3P	MRP	4P	Unit Price (₹)
Fixed	65kA	B1	630	820021	P.O.R.	820031	P.O.R.
Fixed	65kA	B1	800	820022	P.O.R.	820032	P.O.R.
Fixed	65kA	B1	1000	820023	P.O.R.	820033	P.O.R.
Fixed	65kA	B1	1250	820024	P.O.R.	820034	P.O.R.
Fixed	65kA	B1	1600	820025	P.O.R.	820035	P.O.R.
Fixed	65kA	B1	2000	820026	P.O.R.	820036	P.O.R.
Fixed	65kA	B2	2500	820027	P.O.R.	820037	P.O.R.
Fixed	65kA	B2	3200	820051	P.O.R.	820061	P.O.R.
Fixed	65kA	B3	4000	820052	P.O.R.	820062	P.O.R.

HSN Code: 8536



Type	Breaking capacity	Frame	Rating	3P	MRP	4P	Unit Price (₹)
D/O	65kA	B1	630	820121	P.O.R.	820131	P.O.R.
D/O	65kA	B1	800	820122	P.O.R.	820132	P.O.R.
D/O	65kA	B1	1000	820123	P.O.R.	820133	P.O.R.
D/O	65kA	B1	1250	820124	P.O.R.	820134	P.O.R.
D/O	65kA	B1	1600	820125	P.O.R.	820135	P.O.R.
D/O	65kA	B1	2000	820126	P.O.R.	820136	P.O.R.
D/O	65kA	B2	2500	820127	P.O.R.	820137	P.O.R.
D/O	65kA	B2	3200	820151	P.O.R.	820161	P.O.R.
D/O	65kA	B3	4000	820152	P.O.R.	820162	P.O.R.

— optibreak™ — AIR CIRCUIT BREAKER (WITH MICRO PROCESSOR RELEASE)

HSN Code: 8536

	Type	Breaking capacity	Frame	Rating	3P	MRP	4P	Unit Price (₹)
	Fixed	85kA	B3	3200	820071	P.O.R.	820073	P.O.R.
	Fixed	85kA	B3	4000	820072	P.O.R.	820074	P.O.R.

	Type	Breaking capacity	Frame	Rating	3P	MRP	4P	Unit Price (₹)
	D/O	85kA	B3	3200	820171	P.O.R.	820173	P.O.R.
	D/O	85kA	B3	4000	820172	P.O.R.	820174	P.O.R.

— optibreak™ — TRIP FREE SWITCH / SWITCH DIS-CONNECTOR

HSN Code: 8536

	Type	Breaking capacity	Frame	Rating	3P	MRP	4P	Unit Price (₹)
	Fixed	65kA	I1	1000	820201	P.O.R.	820205	P.O.R.
	Fixed	65kA	I1	1250	820202	P.O.R.	820206	P.O.R.
	Fixed	65kA	I1	1600	820203	P.O.R.	820207	P.O.R.
	Fixed	65kA	I1	2000	820211	P.O.R.	820213	P.O.R.
	Fixed	65kA	I2	2500	820212	P.O.R.	820214	P.O.R.
	Fixed	85kA	I3	3200	820215	P.O.R.	820217	P.O.R.
	Fixed	85kA	I3	4000	820216	P.O.R.	820218	P.O.R.

HSN Code: 8536

	Type	Breaking capacity	Frame	Rating	3P	MRP	4P	Unit Price (₹)
	D/O	65kA	I1	1000	820301	P.O.R.	820305	P.O.R.
	D/O	65kA	I1	1250	820302	P.O.R.	820306	P.O.R.
	D/O	65kA	I1	1600	820303	P.O.R.	820307	P.O.R.
	D/O	65kA	I1	2000	820311	P.O.R.	820313	P.O.R.
	D/O	65kA	I2	2500	820312	P.O.R.	820314	P.O.R.
	D/O	85kA	I3	3200	820315	P.O.R.	820317	P.O.R.
	D/O	85kA	I3	4000	820316	P.O.R.	820318	P.O.R.

— optibreak™ — ACCESSORIES

HSN Code: 8538

	Product	Frame	Cat Ref.	Unit Price (₹)
	Release	LSI	820401	P.O.R.
	Release	LSIg	820402	P.O.R.

HSN Code: 8538

	Product	Frame	Cat Ref.	Unit Price (₹)
	Auxiliary contact	-	820411	P.O.R.

HSN Code: 8538

	Product	Frame	Cat Ref.	Unit Price (₹)
	Shunt trip 230 V AC	-	820412	P.O.R.
	Shunt trip 415 V AC	-	820413	P.O.R.
	Shunt trip 110 V DC	-	820414	P.O.R.
	Shunt trip 220 V DC	-	820415	P.O.R.

— optibreak™ — **ACCESSORIES**

HSN Code: 8538

	Product	Frame	Cat Ref.	Unit Price (₹)
	Undervoltage 230VAC	B1, B2 & B3	820417	P.O.R.
	Undervoltage 415VAC	B1, B2 & B3	820419	P.O.R.
	Undervoltage 230VAC(0.3 ~ 5s)	B1, B2 & B3	820421	P.O.R.
	Undervoltage 415VAC(0.3 ~ 5s)	B1, B2 & B3	820423	P.O.R.

HSN Code: 8538

	Product	Frame	Cat Ref.	Unit Price (₹)
	Closing coil 230 V AC	-	820424	P.O.R.
	Closing coil 415 V AC	-	820425	P.O.R.
	Closing coil 110 V DC	-	820426	P.O.R.
	Closing coil 220 V DC	-	820427	P.O.R.

HSN Code: 8538

	Product	Frame	Cat Ref.	Unit Price (₹)
	Motor Operator 230VAC/220VDC	B1	820428	P.O.R.
	Motor Operator 415VAC	B1	820429	P.O.R.
	Motor Operator 110VDC	B1	820430	P.O.R.

HSN Code: 8538

	Product	Frame	Cat Ref.	MRP
	Motor Operator 230VAC/220VDC	B2 & B3	820431	P.O.R.
	Motor Operator 415VAC	B2 & B3	820432	P.O.R.
	Motor Operator 110VDC	B2 & B3	820433	P.O.R.

HSN Code: 8538

	Product	Frame	Cat Ref.	Unit Price (₹)
Ext Neutral CT B1& B2	-	820441	P.O.R.	

HSN Code: 8538

	Product	Frame	Cat Ref.	Unit Price (₹)
	Vertical terminal 3P till 1000A	-	820456	P.O.R.
	Vertical terminal 4P till 1000A	-	820457	P.O.R.
	Vertical terminal 3P till 2000A	-	820458	P.O.R.
	Vertical terminal 4P till 2000A	-	820459	P.O.R.
	Vertical terminal 3P 3200A Fixed	-	820460	P.O.R.
	Vertical terminal 4P 3200A Fixed	-	820462	P.O.R.
	Vertical terminal 3P 3200A D/O	-	820461	P.O.R.
	Vertical terminal 4P 3200A D/O	-	820463	P.O.R.

— optibreak™ — **ACCESSORIES**

HSN Code: 8538

	Product	Frame	Cat Ref.	Unit Price (₹)
	Phase Separator3P Fixed	-	820471	P.O.R.
	Phase Separator3P DO	-	820472	P.O.R.
	Phase Separator4P Fixed	-	820473	P.O.R.
	Phase Separator4P DO	-	820474	P.O.R.

HSN Code: 8538

	Product	Frame	Cat Ref.	Unit Price (₹)
	MIL- LeverFixed	-	820475	P.O.R.
	MIL- LeverDO	-	820476	P.O.R.
	MIL- CableFixed	-	820477	P.O.R.
	MIL- CableDO	-	820478	P.O.R.

HSN Code: 8538

	Product	Frame	Cat Ref.	Unit Price (₹)
	Key-Lock1L + 1k	-	820479	P.O.R.
	Key-Lock2L + 1k	-	820480	P.O.R.
	Key-Lock3L + 1k	-	820481	P.O.R.
	Key-Lock3L + 2k	-	820482	P.O.R.
	Key-Lock5L + 3k	-	820483	P.O.R.

HSN Code: 8538

	Product	Frame	Cat Ref.	Unit Price (₹)
	Door interlock B1,B2	-	820485	P.O.R.

HSN Code: 8538

	Product	Frame	Cat Ref.	Unit Price (₹)
	Door frame fixed B1	-	820486	P.O.R.
	Door frame fixed B2	-	820487	P.O.R.
	Door frame D/O B1	-	820488	P.O.R.
	Door frame D/O B2	-	820489	P.O.R.

HSN Code: 8538

	Product	Frame	Cat Ref.	Unit Price (₹)
	Dust cover B1,B2	-	820490	P.O.R.

HSN Code: 8538

	Product	Frame	Cat Ref.	Unit Price (₹)
	Power module 415V B1,B2	-	820491	P.O.R.
	Power module 230V B1,B2	-	820492	P.O.R.

**FOR A JOB
WELL DONE, HERE IS
ALL THAT YOU NEED.**

OptiPower



— optium™ —

ALL THAT YOU NEED

—optium™— **OPTIUM 1.0 (FIXED TM RANGE)**

HSN Code: 8536



Frame	Breaking capacity	Rating	3P	Unit Price (₹)	4P	Unit Price (₹)
F1	16kA	16	830001	3362	830015	4726
F1	16kA	25	830002	3362	830016	4726
F1	16kA	32	830003	3362	830017	4726
F1	16kA	40	830004	3362	830018	4726
F1	16kA	50	830005	3362	830019	4726
F1	16kA	63	830006	3362	830020	4726
F1	16kA	80	830007	3362	830021	4726
F1	16kA	100	830008	3362	830022	4726
F1	16kA	125	830009	4430	830023	5480

HSN Code: 8536



Frame	Breaking capacity	Rating	3P	Unit Price (₹)	4P	Unit Price (₹)
F1	25kA	16	830031	4324	830045	5452
F1	25kA	25	830032	4324	830046	5452
F1	25kA	32	830033	4324	830047	5452
F1	25kA	40	830034	4324	830048	5452
F1	25kA	50	830035	4324	830049	5452
F1	25kA	63	830036	4324	830050	5452
F1	25kA	80	830037	4324	830051	5452
F1	25kA	100	830038	4324	830052	5452
F1	25kA	125	830039	5642	830053	6982

HSN Code: 8536



Frame	Breaking capacity	Rating	3P	Unit Price (₹)	4P	Unit Price (₹)
F1	36kA	16	830061	6584	830075	7992
F1	36kA	25	830062	6584	830076	7992
F1	36kA	32	830063	6584	830077	7992
F1	36kA	40	830064	6584	830078	7992
F1	36kA	50	830065	6584	830079	7992
F1	36kA	63	830066	6584	830080	7992
F1	36kA	80	830067	6584	830081	7992
F1	36kA	100	830068	6584	830082	7992
F1	36kA	125	830069	7146	830083	9214

HSN Code: 8536



Frame	Breaking capacity	Rating	3P	Unit Price (₹)	4P	Unit Price (₹)
F3	50kA	16	830125	8086	830145	9686
F3	50kA	25	830126	8086	830146	9686
F3	50kA	32	830127	8086	830147	9686
F3	50kA	40	830128	8086	830148	9686
F3	50kA	50	830129	8086	830149	9686
F3	50kA	63	830130	8086	830150	9686
F3	50kA	80	830131	8086	830151	9686
F3	50kA	100	830132	8840	830152	10908
F3	50kA	125	830133	10062	830153	12694

—optium™— OPTIUM 1.0 (FIXED TM RANGE)

HSN Code: 8536

	Frame	Breaking capacity	Rating	3P	Unit Price (₹)	4P	Unit Price (₹)
	F2	16kA	160	830090	5830	830095	7992
F2	16kA	200	830091	7524	830096	8934	
F2	16kA	250	830092	8746	830097	10342	
F2	25kA	160	830100	6300	830105	8996	
F2	25kA	200	830101	8746	830106	12036	
F2	25kA	250	830102	11754	830107	15046	
F2	36kA	160	830110	9056	830115	11566	
F2	36kA	200	830111	10756	830116	13636	
F2	36kA	250	830112	13636	830117	17396	

HSN Code: 8536

	Frame	Breaking capacity	Rating	3P	Unit Price (₹)	4P	Unit Price (₹)
	F3	50kA	160	830134	11660	830154	12412
F3	50kA	200	830135	12694	830155	16266	
F3	50kA	250	830136	14858	830156	20216	

HSN Code: 8536

	Frame	Breaking capacity	Rating	3P	Unit Price (₹)	4P	Unit Price (₹)
	F4	36kA	315	830165	15514	830175	20688
F4	36kA	400	830166	17396	830176	23038	
F4	36kA	500	830167	21628	830177	25860	
F4	36kA	630	830168	21628	830178	25860	

HSN Code: 8536

	Frame	Breaking capacity	Rating	3P	Unit Price (₹)	4P	Unit Price (₹)
	F4	50kA	315	830185	20216	830195	23506
F4	50kA	400	830186	23038	830196	25388	
F4	50kA	500	830187	28680	830197	30560	
F4	50kA	630	830188	28680	830198	30560	

HSN Code: 8536

	Frame	Breaking capacity	Rating	3P	Unit Price (₹)	4P	Unit Price (₹)
	F5	50kA	800	830200	39964	830201	47768

—optium™— OPTIUM 2.0 (ADJUSTABLE TM RANGE)

HSN Code: 8536

	Frame	Breaking capacity	Rating	3P	Unit Price (₹)	4P	Unit Price (₹)
	F1	16kA	25	830222	4418	830236	6018
F1	16kA	32	830223	4418	830237	6018	
F1	16kA	40	830224	4418	830238	6018	
F1	16kA	50	830225	4418	830239	6018	
F1	16kA	63	830226	4418	830240	6018	
F1	16kA	80	830227	4418	830241	6018	
F1	16kA	100	830228	4418	830242	6018	
F1	16kA	125	830229	6112	830243	7992	

—optium™— OPTIUM 2.0 (ADJUSTABLE TM RANGE)

HSN Code: 8536

	Frame	Breaking capacity	Rating	3P	Unit Price (₹)	4P	Unit Price (₹)
	F1	25kA	25	830252	4796	830266	6584
	F1	25kA	32	830253	4796	830267	6584
	F1	25kA	40	830254	4796	830268	6584
	F1	25kA	50	830255	4796	830269	6584
	F1	25kA	63	830256	4796	830270	6584
	F1	25kA	80	830257	4796	830271	6584
	F1	25kA	100	830258	4796	830272	6584
	F1	25kA	125	830259	6112	830273	8330

HSN Code: 8536

	Frame	Breaking capacity	Rating	3P	Unit Price (₹)	4P	Unit Price (₹)
	F3	36kA	16	830305	6394	830325	8180
	F3	36kA	25	830306	6394	830326	8180
	F3	36kA	32	830307	6394	830327	8180
	F3	36kA	40	830308	6394	830328	8180
	F3	36kA	50	830309	6394	830329	8180
	F3	36kA	63	830310	6394	830330	8180
	F3	36kA	80	830311	6394	830331	8180
	F3	36kA	100	830312	6584	830332	8180
F3	36kA	125	830313	7898	830333	9880	

HSN Code: 8536

	Frame	Breaking capacity	Rating	3P	Unit Price (₹)	4P	Unit Price (₹)
	F3	50kA	16	830345	9214	830365	10342
	F3	50kA	25	830346	9214	830366	10342
	F3	50kA	32	830347	9214	830367	10342
	F3	50kA	40	830348	9214	830368	10342
	F3	50kA	50	830349	9214	830369	10342
	F3	50kA	63	830350	9214	830370	10342
	F3	50kA	80	830351	9214	830371	10342
	F3	50kA	100	830352	9214	830372	10342
F3	50kA	125	830353	10342	830373	12224	

HSN Code: 8536

	Frame	Breaking capacity	Rating	3P	Unit Price (₹)	4P	Unit Price (₹)
	F2	16kA	160	830280	7712	830285	9874
	F2	16kA	200	830281	10248	830286	12412
	F2	16kA	250	830282	12694	830287	15588
	F2	25kA	160	830290	8274	830295	10342
	F2	25kA	200	830291	10846	830296	12788
	F2	25kA	250	830292	13560	830297	15798
	F3	36kA	160	830314	10156	830334	11848
	F3	36kA	200	830315	11754	830335	15982
F3	36kA	250	830316	17434	830336	21502	

—optium™— OPTIUM 2.0 (ADJUSTABLE TM RANGE)

HSN Code: 8536

	Frame	Breaking capacity	Rating	3P	Unit Price (₹)	4P	Unit Price (₹)
	F3	50kA	160	830354	11284	830374	12976
	F3	50kA	200	830355	13164	830375	16454
	F3	50kA	250	830356	18806	830376	23038

HSN Code: 8536

	Frame	Breaking capacity	Rating	3P	Unit Price (₹)	4P	Unit Price (₹)
	F4	25kA	315	830385	19668	830387	24448
	F4	25kA	400	830386	20136	830388	24786
	F4	36kA	315	830390	20788	830395	25860
	F4	36kA	400	830391	21156	830396	26800
	F4	36kA	500	830392	24448	830397	30560
	F4	36kA	630	830393	24448	830398	30560
	F4	50kA	315	830400	24918	830405	27740
	F4	50kA	400	830401	26328	830406	30560
	F4	50kA	500	830402	27268	830407	34792
	F4	50kA	630	830403	27268	830408	34792

HSN Code: 8536

	Frame	Breaking capacity	Rating	3P	Unit Price (₹)	4P	Unit Price (₹)
	F5	36kA	800	830410	39492	830413	52658
	F5	36kA	1000	830411	61160	830414	74284
	F5	36kA	1250	830412	66764	830415	83686
	F5	50kA	800	830416	43254	830419	58300
	F5	50kA	1000	830417	63942	830420	78046
	F5	50kA	1250	830418	70522	830421	88390

—optium™— OPTIUM 2.1 (ELECTRONIC / MICRO -PROCESSOR RANGE)

HSN Code: 8536

	Frame	Breaking capacity	Rating	3P	Unit Price (₹)	4P	Unit Price (₹)
	F3	36kA	40	830430	12694	830440	15986
	F3	36kA	100	830431	12694	830441	15986
	F3	36kA	160	830432	15798	830442	18994
	F3	36kA	250	830433	19934	830443	24178
	F3	50kA	40	830450	13916	830460	16738
	F3	50kA	100	830451	14576	830461	17866
	F3	50kA	160	830452	16588	830462	20688
	F3	50kA	250	830453	21816	830463	27268

HSN Code: 8536

	Frame	Breaking capacity	Rating	3P	Unit Price (₹)	4P	Unit Price (₹)
	F4	36kA	400	830510	25200	830512	32912
	F4	36kA	630	830511	28396	830513	35732
	F4	50kA	400	830514	29150	830516	36390
F4	50kA	630	830515	29902	830517	37330	

—optium™— **OPTIUM 2.1 (ELECTRONIC/ MICRO -PROCESSOR RANGE)**

HSN Code: 8536

	Frame	Breaking capacity	Rating	3P	Unit Price (₹)	4P	Unit Price (₹)
	F5	36kA	800	830540	47862	830542	59710
	F5	36kA	1250	830541	68642	830543	87448
	F5	50kA	800	830544	51718	830546	67704
	F5	50kA	1250	830545	79928	830547	108136

—optium™— **OPTIUM 2.2 (ELECTRONIC- MICRO -PROCESSOR RANGE)**

HSN Code: 8536

	Frame	Breaking capacity	Rating	3P	Unit Price (₹)	4P	Unit Price (₹)
	F3	36kA	40	830470	14670	830480	18336
	F3	36kA	100	830471	14670	830481	18336
	F3	36kA	160	830472	16926	830482	20970
	F3	36kA	250	830473	21628	830483	26612
	F3	50kA	40	830490	15986	830500	19276
	F3	50kA	100	830491	15986	830501	19276
	F3	50kA	160	830492	18806	830502	22756
	F3	50kA	250	830493	24448	830503	29338

—optium™— **OPTIUM 2.2 (ELECTRONIC -MICRO -PROCESSOR RANGE)**

HSN Code: 8536

	Frame	Breaking capacity	Rating	3P	Unit Price (₹)	4P	Unit Price (₹)
	F4	36kA	400	830520	32912	830522	39024
	F4	36kA	630	830521	37614	830523	47956
	F4	50kA	400	830524	40432	830526	42784
	F4	50kA	630	830525	53596	830527	53596

HSN Code: 8536

	Frame	Breaking capacity	Rating	3P	Unit Price (₹)	4P	Unit Price (₹)
	F5	36kA	800	830550	53596	830552	67704
	F5	36kA	1250	830551	71464	830553	93560
	F5	50kA	800	830554	63942	830556	83726
	F5	50kA	1250	830555	83686	830557	108606

—optium™— **ACCESSORIES**

HSN Code: 8538

	Product	Frame	Cat Ref.	Unit Price (₹)
	Auxiliary contact	F1 F2 F3	830691	800
	Auxiliary contact	F4-F5	830693	1050
	Alarm Contact	F1 F2 F3	830692	800
	Alarm Contact	F4-F5	830693	1050
	Auxiliary contact / Alarm Contact	F1 F2 F3	830694	1200

—optium™— **ACCESSORIES**

HSN Code: 8538

	Product	Frame	Cat Ref.	Unit Price (₹)
	"Shunt trip 24 V AC/DC"	F1 F2 F3	830602	980
	"Shunt trip 110 V AC/DC"	F1 F2 F3	830603	980
	"Shunt trip 230 V AC/DC"	F1 F2 F3	830604	980
	"Shunt trip 415 V AC/DC"	F1 F2 F3	830605	980
	"Shunt trip 24 V AC/DC"	F4 F5	830642	1800
	"Shunt trip 110 V AC/DC"	F4 F5	830643	1800
	"Shunt trip 230 V AC/DC"	F4 F5	830644	1800
	"Shunt trip 415 V AC/DC"	F4 F5	830645	1800

HSN Code: 8538

	Product	Frame	Cat Ref.	Unit Price (₹)
	"Undervoltage 24 V DC"	F1 F2 F3	830606	1500
	"Undervoltage 110V AC"	F1 F2 F3	830607	1500
	"Undervoltage 230V AC"	F1 F2 F3	830608	1500
	"Undervoltage 415V AC"	F1 F2 F3	830609	1500
	"Undervoltage 24 V DC"	F4 F5	830646	1600
	"Undervoltage 110V AC"	F4 F5	830647	1600
	"Undervoltage 230V AC"	F4 F5	830648	1600
"Undervoltage 415V AC"	F4 F5	830649	1600	

HSN Code: 8538

	Product	Frame	Cat Ref.	Unit Price (₹)
	Rotary Handle Direct	F1	830611	1150
	Rotary Handle vary-Depth	F1	830612	1150
	Rotary Handle Direct	F2 F3	830626	1350
	Rotary Handle vary-Depth	F2 F3	830627	1350
	Rotary Handle Direct	F4	830651	1600
	Rotary Handle vary-Depth	F4	830652	1600
	Rotary Handle Direct	F5	830671	3100
Rotary Handle vary-Depth	F5	830672	3100	

HSN Code: 8538

	Product	Frame	Cat Ref.	Unit Price (₹)
	Ronis lock Direct RH	F1 F2 F3	830613	1250
	Ronis lock Vary-Depth RH	F1 F2 F3	830614	1250
	Ronis lock Vary-Depth RH	F4	830653	1700
Ronis lock Vary-Depth RH	F5	830673	1700	

HSN Code: 8538

	Product	Frame	Cat Ref.	Unit Price (₹)
	Padlock Off position	F1 F2 F3	830615	1700
	Padlock Off position	F4	830654	1700
Padlock Off position	F5	830674	1700	

HSN Code: 8538

	Product	Frame	Cat Ref.	Unit Price (₹)
	Phase insulators 3P	F1 F2	830616	P.O.R.
	Phase insulators 3P	F3	830628	P.O.R.
	Phase insulators 3P	F4	830655	P.O.R.
	Phase insulators 3P	F5	830675	P.O.R.
	Phase insulators 4P	F1 F2	830617	P.O.R.
	Phase insulators 4P	F3	830629	P.O.R.
	Phase insulators 4P	F4	830656	P.O.R.
Phase insulators 4P	F5	830676	P.O.R.	

—optium™— ACCESSORIES

HSN Code: 8538

Product	Frame	Cat Ref.	Unit Price (₹)
Terminal cover 3P	F4	830657	P.O.R.
Terminal cover 3P	F5	830677	P.O.R.
Terminal cover 4P	F4	830658	P.O.R.
Terminal cover 4P	F5	830678	P.O.R.
Terminal shield 3P	F5	830679	P.O.R.
Terminal shield 4P	F5	830680	P.O.R.

HSN Code: 8538



Product	Frame	Cat Ref.	Unit Price (₹)
Spreaders 3P	F1	830618	280
Spreaders 4P	F1	830619	410
Spreaders 3P	F2 F3	830632	750
Spreaders 4P	F2 F3	830633	1500
Spreaders 3P	F4	830659	2400
Spreaders 4P	F4	830660	3500
Spreaders 3P 800/1000A	F5	830681	7500
Spreaders 4P 800/1000A	F5	830682	11000
Spreaders 3P 1250A	F5	830685	7800
Spreaders 4P 1250A	F5	830686	11500

HSN Code: 8538



Product	Frame	Cat Ref.	Unit Price (₹)
Cages 3P upto 50A	F1	830620	P.O.R.
Cages 4P upto 50A	F1	830621	P.O.R.
Cages 3P 63 to 100A	F1	830622	P.O.R.
Cages 4P 63 to 100A	F1	830623	P.O.R.
Cages 3P 125A	F1	830624	P.O.R.
Cages 4P 125A	F1	830625	P.O.R.
Cages 3P	F2	830630	P.O.R.
Cages 4P	F2	830631	P.O.R.
Cages 3P	F3	830634	P.O.R.
Cages 4P	F3	830635	P.O.R.
Cages 3P	F4	830661	P.O.R.
Cages 4P	F4	830662	P.O.R.
Cages 3P	F5	830683	P.O.R.
Cages 4P	F5	830684	P.O.R.

**FOR A JOB
WELL DONE, HERE IS
ALL THAT YOU NEED.**

OptiPower



— opticon™ —

ALL THAT YOU NEED

— opticon™ — POWER CONTACTORS

HSN Code: 8536

	Type	Auxiliary Contact	Rating(A) AC3	Coil Voltage 24V AC	Unit Price (₹)	Coil Voltage 24V DC	Unit Price (₹)	Coil Voltage 48V AC	Unit Price (₹)	Coil Voltage 48V DC	Unit Price(₹)
	3P	1NO	9	850001	742	850002	1222	850003	742	850004	1222
	3P	1NO	12	850011	838	850012	1388	850013	838	850014	1388
	3P	1NO	18	850021	958	850022	1634	850023	958	850024	1634
	3P	1NO	25	850031	1338	850032	2422	850033	1338	850034	2422
	3P	1NO	32	850041	2836	850042	4894	850043	2836	850044	4894

HSN Code: 8536

	Type	Auxiliary Contact	Rating(A) AC3	Coil Voltage 110V AC	Unit Price (₹)	Coil Voltage 230V AC	Unit Price (₹)	Coil Voltage 415V AC	Unit Price (₹)
	3P	1NO	9	850005	742	850006	742	850007	742
	3P	1NO	12	850015	838	850016	838	850017	838
	3P	1NO	18	850025	958	850026	958	850027	958
	3P	1NO	25	850035	1338	850036	1338	850037	1338
	3P	1NO	32	850045	2836	850046	2836	850047	2836

HSN Code: 8536

	Type	Auxiliary Contact	Rating(A) AC3	Coil Voltage 24V AC	Unit Price (₹)	Coil Voltage 24V DC	Unit Price (₹)	Coil Voltage 48V AC	Unit Price (₹)	Coil Voltage 48V DC	Unit Price(₹)
	3P	1NC	9	850101	742	850102	1222	850103	742	850104	1222
	3P	1NC	12	850111	838	850112	1388	850113	838	850114	1388
	3P	1NC	18	850121	958	850122	1634	850123	958	850124	1634
	3P	1NC	25	850131	1338	850132	2422	850133	1338	850134	2422
	3P	1NC	32	850141	2836	850142	4894	850143	2836	850144	4894

HSN Code: 8536

	Type	Auxiliary Contact	Rating(A) AC3	Coil Voltage 110V AC	Unit Price (₹)	Coil Voltage 230V AC	Unit Price (₹)	Coil Voltage 415V AC	Unit Price (₹)
	3P	1NC	9	850105	742	850106	742	850107	742
	3P	1NC	12	850115	838	850116	838	850117	838
	3P	1NC	18	850125	958	850126	958	850127	958
	3P	1NC	25	850135	1338	850136	1338	850137	1338
	3P	1NC	32	850145	2836	850146	2836	850147	2836

HSN Code: 8536

	Type	Auxiliary Contact	Rating(A) AC3	Coil Voltage 24V AC	Unit Price (₹)	Coil Voltage 24V DC	Unit Price (₹)	Coil Voltage 48V AC	Unit Price (₹)	Coil Voltage 48V DC	Unit Price(₹)
	3P	1NO + 1NC	40	850151	3976	850152	6456	850153	3976	850154	6456
	3P	1NO + 1NC	50	850161	5348	850162	8062	850163	5348	850164	8062
	3P	1NO + 1NC	65	850171	7314	850172	9282	850173	7314	850174	9282
	3P	1NO + 1NC	80	850181	9080	850182	11250	850183	9080	850184	11250
	3P	1NO + 1NC	95	850191	10896	850192	14012	850193	10896	850194	14012

— opticon™ — POWER CONTACTORS

HSN Code: 8536

	Type	Auxiliary Contact	Rating(A) AC3	Coil Voltage 110V AC	Unit Price (₹)	Coil Voltage 230V AC	Unit Price (₹)	Coil Voltage 415V AC	Unit Price (₹)
	3P	1NO+1NC	40	850155	3976	850156	3976	850157	3976
	3P	1NO+1NC	50	850165	5348	850166	5348	850167	5348
	3P	1NO+1NC	65	850175	7314	850176	7314	850177	7314
	3P	1NO+1NC	80	850185	9080	850186	9080	850187	9080
	3P	1NO+1NC	95	850195	10896	850196	10896	850197	10896

HSN Code: 8536

	Type	Power Contact	Auxiliary Contact	Rating(A) AC3 24V AC	Coil Voltage 48V AC	Unit Price (₹)	Coil Voltage 110V AC	Unit Price (₹)	Coil Voltage 110V AC	Unit Price (₹)
	3P	3NO	-	115	850201	13318	850203	13318	850205	13318
	3P	3NO	-	150	850211	17858	850213	17858	850215	17858
	3P	3NO	-	185	850221	23506	850223	23506	850225	23506
	3P	3NO	-	225	850231	24666	850233	24666	850235	24666
	3P	3NO	-	265	850241	28750	850243	28750	850245	28750
	3P	3NO	-	330	850251	36218	850253	36218	850255	36218
	3P	3NO	-	400	-	-	850263	43884	850265	43884
	3P	3NO	-	500	-	-	850273	63556	850275	63556
	3P	3NO	-	630	-	-	850283	88272	850285	88272

HSN Code: 8536

	Type	Power Contact	Auxiliary Contact	Rating(A) AC3	Coil Voltage 230V AC	Unit Price (₹)	Coil Voltage 415V AC	Unit Price (₹)
	3P	3NO	-	115	850206	13318	850207	13318
	3P	3NO	-	150	850216	17858	850217	17858
	3P	3NO	-	185	850226	23506	850227	23506
	3P	3NO	-	225	850236	24666	850237	24666
	3P	3NO	-	265	850246	28750	850247	28750
	3P	3NO	-	330	850256	36218	850257	36218
	3P	3NO	-	400	850266	43884	850267	43884
	3P	3NO	-	500	850276	63556	850277	63556
	3P	3NO	-	630	850286	88272	850287	88272

HSN Code: 8536

	Type	Power Contact	Auxiliary Contact	Rating(A) AC1	Rating(A) AC3	Coil Voltage 24V AC	Unit Price (₹)	Coil Voltage 24V DC	Unit Price (₹)	Coil Voltage 48V AC	Unit Price (₹)	Coil Voltage 48V DC	Unit Price (₹)
	4P	4NO	-	20	9	850301	1084	850302	2128	850303	1084	850304	2128
	4P	4NO	-	25	12	850311	1188	850312	2708	850313	1188	850314	2708
	4P	4NO	-	40	25	850321	1768	850322	3964	850323	1768	850324	3964
	4P	4NO	-	60	40	850331	4290	850332	6596	850333	4290	850334	6596
	4P	4NO	-	80	50	850341	5538	850342	8456	850343	5538	850344	8456
	4P	4NO	-	80	65	850351	7260	850352	11158	850353	7260	850354	11158
	4P	4NO	-	110	80	850361	8246	850362	12414	850363	8246	850364	12414
	4P	4NO	-	125	95	850371	10198	850372	13622	850373	10198	850374	13622
	4P	4NO	-	200	115	850381	17350	-	-	850383	17350	-	-
	4P	4NO	-	250	150	850391	19660	-	-	850393	19660	-	-
	4P	4NO	-	275	185	850401	33418	-	-	850403	33418	-	-
	4P	4NO	-	315	225	850411	35822	-	-	850413	35822	-	-
	4P	4NO	-	500	400	-	-	-	-	850423	57814	-	-
	4P	4NO	-	700	500	-	-	-	-	850433	63774	-	-
	4P	4NO	-	1000	630	-	-	-	-	850443	115536	-	-

—opticon™— POWER CONTACTORS

HSN Code: 8536



Type	Power Contact	Auxiliary Contact	Rating(A) AC1	Rating(A) AC3	Coil Voltage 110V AC	Unit Price (₹)	Coil Voltage 230V AC	Unit Price (₹)	Coil Voltage 415V AC	Unit Price (₹)
4P	4NO	-	20	9	850305	1084	850306	1084	850307	1084
4P	4NO	-	25	12	850315	1188	850316	1188	850317	1188
4P	4NO	-	40	25	850325	1768	850326	1768	850327	1768
4P	4NO	-	60	40	850335	4290	850336	4290	850337	4290
4P	4NO	-	80	50	850345	5538	850346	5538	850347	5538
4P	4NO	-	80	65	850355	7260	850356	7260	850357	7260
4P	4NO	-	110	80	850365	8246	850366	8246	850367	8246
4P	4NO	-	125	95	850375	10198	850376	10198	850377	10198
4P	4NO	-	200	115	850385	17350	850386	17350	850387	17350
4P	4NO	-	50	150	850395	19660	850396	19660	850397	19660
4P	4NO	-	275	185	850405	33418	850406	33418	850407	33418
4P	4NO	-	315	225	850415	35822	850416	35822	850417	35822
4P	4NO	-	500	400	850425	57814	850426	57814	850427	57814
4P	4NO	-	700	500	850435	63774	850436	63774	850437	63774
4P	4NO	-	1000	630	850445	115536	850446	115536	850447	115536

HSN Code: 8536



Type	Power Contact*	Auxiliary Contact*	Rating(A) AC1	Rating(A) AC3	Coil Voltage 24V AC	Unit Price (₹)	Coil Voltage 24V DC	Unit Price (₹)	Coil Voltage 48V AC	Unit Price (₹)	Coil Voltage 48V DC	Unit Price (₹)
4P	2NO+2NC	-	20	9	850501	1314	850502	2206	850503	1314	850504	2206
4P	2NO+2NC	-	25	12	850511	1580	850512	2942	850513	1580	850514	2942
4P	2NO+2NC	-	40	25	850521	2414	850522	5100	850523	2414	850524	5100
4P	2NO+2NC	-	60	40	850531	7206	850532	10694	850533	7206	850534	10694
4P	2NO+2NC	-	80	50	850541	8632	850542	13290	850543	8632	850544	13290
4P	2NO+2NC	-	80	65	850551	9702	850552	14042	850553	9702	850554	14042
4P	2NO+2NC	-	110	80	850561	10860	850562	15742	850563	10860	850564	15742
4P	2NO+2NC	-	125	95	850571	12596	850572	16236	850573	12596	850574	16236
4P	4NO	2NO+2NC	200	115	850581	19980	-	-	850583	19980	-	-
4P	4NO	2NO+2NC	250	150	850591	22616	-	-	850593	22616	-	-
4P	4NO	2NO+2NC	275	185	850601	38482	-	-	850603	38482	-	-
4P	4NO	2NO+2NC	315	225	850611	41096	-	-	850613	41096	-	-
4P	4NO	2NO+2NC	500	400	-	-	-	-	850623	66290	-	-
4P	4NO	2NO+2NC	700	500	-	-	-	-	850633	73522	-	-
4P	4NO	2NO+2NC	1000	630	-	-	-	-	850643	128698	-	-

— opticon™ — POWER CONTACTORS

HSN Code: 8536



Type	Power Contact*	Auxiliary Contact*	Rating(A) AC1	Rating(A) AC3	Coil Voltage 110V AC	Unit Price (₹)	Coil Voltage 230V AC	Unit Price (₹)	Coil Voltage 415V AC	Unit Price (₹)
4P	2NO+2NC	-	20	9	850505	1314	850506	1314	850507	1314
4P	2NO+2NC	-	25	12	850515	1580	850516	1580	850517	1580
4P	2NO+2NC	-	40	25	850525	2414	850526	2414	850527	2414
4P	2NO+2NC	-	60	40	850535	7206	850536	7206	850537	7206
4P	2NO+2NC	-	80	50	850545	8632	850546	8632	850547	8632
4P	2NO+2NC	-	80	65	850555	9702	850556	9702	850557	9702
4P	2NO+2NC	-	110	80	850565	10860	850566	10860	850567	10860
4P	2NO+2NC	-	125	95	850575	12596	850576	12596	850577	12596
4P	4NO	2NO+2NC	200	115	850585	19980	850586	19980	850587	19980
4P	4NO	2NO+2NC	250	150	850595	22616	850596	22616	850597	22616
4P	4NO	2NO+2NC	275	185	850605	38482	850606	38482	850607	38482
4P	4NO	2NO+2NC	315	225	850615	41096	850616	41096	850617	41096
4P	4NO	2NO+2NC	500	400	850625	66290	850626	66290	850627	66290
4P	4NO	2NO+2NC	700	500	850635	73522	850636	73522	850637	73522
4P	4NO	2NO+2NC	1000	630	850645	128698	850646	128698	850647	128698

— opticon™ — MINI CONTACTORS

HSN Code: 8536



Type	Contact*	Rating(A) AC3	Coil Voltage 24V AC	Unit Price (₹)	Coil Voltage 48V AC	Unit Price (₹)	Coil Voltage 110V AC	Unit Price (₹)	Coil Voltage 230V AC	Unit Price (₹)
3P	1NO	9	850701	808	850703	808	850705	808	850706	808
3P	1NO	12	850711	858	850713	858	850715	858	850716	858
3P	1NC	9	850721	808	850723	808	850725	808	850726	808
3P	1NC	12	850731	858	850733	858	850735	858	850736	858
4P	4NO	9	-	-	-	-	-	-	850751	990
4P	2NO+2NC	9	-	-	-	-	-	-	850771	990

*3P mini contactors contacts are with auxiliary contacts and 4P mini contactors are with power contacts

HSN Code: 8536



Type	Contact*	Rating(A) AC3	Coil Voltage 415V AC	Unit Price (₹)
3P	1NO	9	850707	808
3P	1NO	12	850717	858
3P	1NC	9	850727	808
3P	1NC	12	850737	858
4P	4NO	9	850752	990
4P	2NO+2NC	9	850772	990

*3P mini contactors contacts are with auxiliary contacts and 4P mini contactors are with power contacts

— opticon™ — CAPACITOR DUTY CONTACTORS

HSN Code: 8536



Type	Auxiliary Contact	Rating (KVAR)	Coil Voltage 230V AC	Unit Price (₹)	Coil Voltage 415V AC	Unit Price (₹)
3P	2NO	12	850804	1862	850805	1862
3P	2NO	16	850814	2640	850815	2640
3P	2NO	20	850824	3080	850825	3080
3P	2NO+1NC	25	850834	3080	850835	3080
3P	2NO+1NC	30	850844	6634	850845	6634
3P	2NO+1NC	37	850854	6634	850855	6634
3P	2NO+1NC	45	850864	9840	850865	9840
3P	2NO+1NC	50	850874	9840	850875	9840

— opticon™ — CONTROL RELAY

HSN Code: 8536

	Type	Auxiliary Contact	Rating(A)	Coil Voltage 24V AC	Unit Price (₹)	Coil Voltage 24V DC	Unit Price (₹)	Coil Voltage 48V AC	Unit Price (₹)	Coil Voltage 48V DC	Unit Price (₹)
	-	4NO	-	850881	852	850882	1332	850883	852	850884	1332
	-	3NO + 1NC	-	850891	852	850892	1332	850893	852	850894	1332
	-	2NO + 2NC	-	850901	852	850902	1332	850903	852	850904	1332

HSN Code: 8536

	Type	Auxiliary Contact	Rating(A)	Coil Voltage 110V AC	Unit Price (₹)	Coil Voltage 230V AC	Unit Price (₹)	Coil Voltage 415V AC	Unit Price (₹)
	-	4NO	-	850885	852	850886	852	850887	852
	-	3NO + 1NC	-	850895	852	850896	852	850897	852
	-	2NO + 2NC	-	850905	852	850906	852	850907	852

— opticon™ — ACCESSORIES

HSN Code: 8536

	Type	Auxiliary Contact	Rating(A)	Cat. Ref	Unit Price (₹)
	Add on block for Power contactor - Front Mounted	2 NO	-	851001	268
	Add on block for Power contactor - Front Mounted	1 NO + 1NC	-	851002	268
	Add on block for Power contactor - Front Mounted	2 NC	-	851003	268
	Add on block for Power contactor - Front Mounted	4 NO	-	851004	410
	Add on block for Power contactor - Front Mounted	3 NO + 1 NC	-	851005	410
	Add on block for Power contactor - Front Mounted	2 NO + 2 NC	-	851006	410
	Add on block for Power contactor - Front Mounted	1 NO + 3 NC	-	851007	410
	Add on block for Power contactor - Front Mounted	4 NC	-	851008	410
	Add on block for Power contactor - Side Mounted	1 NO + 1NC	-	851009	410

HSN Code: 8538

	Type	Auxiliary Contact	Rating(A)	Cat. Ref	Unit Price (₹)
	Add on block for Mini contactor - Front Mounted	2 NO	-	851121	232
	Add on block for Mini contactor - Front Mounted	1 NO + 1NC	-	851122	232
	Add on block for Mini contactor - Front Mounted	2 NC	-	851123	232
	Add on block for Mini contactor - Front Mounted	4 NO	-	851124	376
	Add on block for Mini contactor - Front Mounted	3 NO + 1 NC	-	851125	376
	Add on block for Mini contactor - Front Mounted	2 NO + 2 NC	-	851126	376
	Add on block for Mini contactor - Front Mounted	1 NO + 3 NC	-	851127	376
	Add on block for Mini contactor - Front Mounted	4 NC	-	851128	376

HSN Code: 8538

	Type	Contact	Rating	Cat. Ref	Unit Price (₹)
	Mechanical interlock	-	9 A to 32 A	851011	410
	Mechanical interlock	-	40 A to 95 A	851012	1182
	Mechanical interlock	-	115 A to 150 A	851013	2632
	Mechanical interlock	-	185 A to 225 A	851014	3008
	Mechanical interlock	-	265 A to 400 A	851015	3438
	Mechanical interlock	-	500 A to 630 A	851016	3438

— opticon™ — ACCESSORIES

HSN Code: 8536

	Type	Auxiliary Contact	Operation	Rating	Cat. Ref	Unit Price (₹)
	Timer blocks	1 NO + 1NC	On delay	0.1 to 3 sec	851021	1418
	Timer blocks	1 NO + 1NC	On delay	0.1 to 30 sec	851022	1418
	Timer blocks	1 NO + 1NC	On delay	10 to 180 sec	851023	1418
	Timer blocks	1 NO + 1NC	Off delay	0.1 to 3 sec	851024	1418
	Timer blocks	1 NO + 1NC	Off delay	0.1 to 30 sec	851025	1418
	Timer blocks	1 NO + 1NC	Off delay	10 to 180 sec	851026	1418

HSN Code: 8538

	Type	Voltage	Rating	Cat. Ref	Unit Price (₹)
	Spare coil for Power Contactor	24 V AC	9 to 18 A	851031	468
	Spare coil for Power Contactor	48 V AC	9 to 18 A	851041	468
	Spare coil for Power Contactor	110 V AC	9 to 18 A	851051	468
	Spare coil for Power Contactor	240 V AC	9 to 18 A	851061	468
	Spare coil for Power Contactor	415 V AC	9 to 18 A	851071	468
	Spare coil for Power Contactor	24 V DC	9 to 18 A	851081	644
	Spare coil for Power Contactor	48 V DC	9 to 18 A	851091	644
	Spare coil for Power Contactor	24 V AC	25 to 32 A	851032	548
	Spare coil for Power Contactor	48 V AC	25 to 32 A	851042	548
	Spare coil for Power Contactor	110 V AC	25 to 32 A	851052	548
	Spare coil for Power Contactor	240 V AC	25 to 32 A	851062	548
	Spare coil for Power Contactor	415 V AC	25 to 32 A	851072	548
	Spare coil for Power Contactor	24 V DC	25 to 32 A	851082	790
	Spare coil for Power Contactor	48 V DC	25 to 32 A	851092	790
	Spare coil for Power Contactor	24 V AC	40 to 95 A	851033	1424
	Spare coil for Power Contactor	48 V AC	40 to 95 A	851043	1424
	Spare coil for Power Contactor	110 V AC	40 to 95 A	851053	1424
	Spare coil for Power Contactor	240 V AC	40 to 95 A	851063	1424
	Spare coil for Power Contactor	415 V AC	40 to 95 A	851073	1424
	Spare coil for Power Contactor	24 V DC	40 to 95 A	851083	1800
	Spare coil for Power Contactor	48 V DC	40 to 95 A	851093	1800
	Spare coil for Power Contactor	110 V AC	115 to 150 A	851054	3052
	Spare coil for Power Contactor	240 V AC	115 to 150 A	851064	3052
	Spare coil for Power Contactor	415 V AC	115 to 150 A	851074	3052

HSN Code: 8538

Type	Voltage	Rating	Cat. Ref	Unit Price (₹)
Spare coil for Power Contactor	110 V AC	185 to 225 A	851055	4242
Spare coil for Power Contactor	240 V AC	185 to 225 A	851065	4242
Spare coil for Power Contactor	415 V AC	185 to 225 A	851075	4242
Spare coil for Power Contactor	110 V AC	265 to 330 A	851056	4886
Spare coil for Power Contactor	240 V AC	265 to 330 A	851066	4886
Spare coil for Power Contactor	415 V AC	265 to 330 A	851076	4886
Spare coil for Power Contactor	110 V AC	400 A	851057	9972
Spare coil for Power Contactor	240 V AC	400 A	851067	9972
Spare coil for Power Contactor	415 V AC	400 A	851077	9972
Spare coil for Power Contactor	110 V AC	500 A	851058	16646
Spare coil for Power Contactor	240 V AC	500 A	851068	16646
Spare coil for Power Contactor	415 V AC	500 A	851078	16646
Spare coil for Power Contactor	110 V AC	630 A	851059	16968
Spare coil for Power Contactor	240 V AC	630 A	851069	16968
Spare coil for Power Contactor	415 V AC	630 A	851079	16968

— opticon™ — THERMAL OVERLOAD RELAY

HSN Code: 8536



Type	Auxiliary Contact	Rating	Cat. Ref	Unit Price (₹)
Thermal Overload Relay for Power Contactor	1 NO + 1NC	0.1-0.16A	851151	1116
Thermal Overload Relay for Power Contactor	1 NO + 1NC	0.16-0.25A	851152	1116
Thermal Overload Relay for Power Contactor	1 NO + 1NC	0.25-0.40A	851153	1116
Thermal Overload Relay for Power Contactor	1 NO + 1NC	0.40-0.63A	851154	1116
Thermal Overload Relay for Power Contactor	1 NO + 1NC	0.63-1.0A	851155	1116
Thermal Overload Relay for Power Contactor	1 NO + 1NC	1.0-1.6A	851156	1116
Thermal Overload Relay for Power Contactor	1 NO + 1NC	1.25-2.0A	851157	1116
Thermal Overload Relay for Power Contactor	1 NO + 1NC	1.6-2.5A	851158	1116
Thermal Overload Relay for Power Contactor	1 NO + 1NC	2.5-4.0A	851159	1116
Thermal Overload Relay for Power Contactor	1 NO + 1NC	4.0-6.0A	851160	1116
Thermal Overload Relay for Power Contactor	1 NO + 1NC	5.5-8.0A	851161	1116

HSN Code: 8536



Type	Auxiliary Contact	Rating	Cat. Ref	Unit Price (₹)
Thermal Overload Relay for Power Contactor	1 NO + 1NC	7.0-10.0A	851162	1116
Thermal Overload Relay for Power Contactor	1 NO + 1NC	9.0-13.0A	851163	1116
Thermal Overload Relay for Power Contactor	1 NO + 1NC	12.0-18.0A	851164	1250
Thermal Overload Relay for Power Contactor	1 NO + 1NC	17.0-25.0A	851165	1250
Thermal Overload Relay for Power Contactor	1 NO + 1NC	23.0-32.0A	851166	1834
Thermal Overload Relay for Power Contactor	1 NO + 1NC	28.0-36.0A	851167	1834
Thermal Overload Relay for Power Contactor	1 NO + 1NC	23.0-32.0A	851168	1834
Thermal Overload Relay for Power Contactor	1 NO + 1NC	30.0-40.0A	851169	1834
Thermal Overload Relay for Power Contactor	1 NO + 1NC	37.0-50.0A	851170	1834
Thermal Overload Relay for Power Contactor	1 NO + 1NC	48.0-65.0A	851171	1834
Thermal Overload Relay for Power Contactor	1 NO + 1NC	55.0-70.0A	851172	1834
Thermal Overload Relay for Power Contactor	1 NO + 1NC	63.0-80.0A	851173	1834
Thermal Overload Relay for Power Contactor	1 NO + 1NC	80.0-93.0A	851174	1834
Thermal Overload Relay for Power Contactor	1 NO + 1NC	30-50A	851175	2480
Thermal Overload Relay for Power Contactor	1 NO + 1NC	48-80A	851176	3564
Thermal Overload Relay for Power Contactor	1 NO + 1NC	60-100A	851177	6188
Thermal Overload Relay for Power Contactor	1 NO + 1NC	90-150A	851179	6188
Thermal Overload Relay for Power Contactor	1 NO + 1NC	200-330A	851184	6188
Thermal Overload Relay for Power Contactor	1 NO + 1NC	300-500A	851186	7870
Thermal Overload Relay for Power Contactor	1 NO + 1NC	380-630A	851187	21186

HSN Code: 8538



Type	Contact	Rating	Cat. Ref	Unit Price (₹)
Mounting Bracket	-	Relay 25	851190	322
Mounting Bracket	-	Relay 36	851191	378
Mounting Bracket	-	Relay 93	851192	840

HSN Code: 8536



Type	Auxiliary Contact	Rating	Cat. Ref	Unit Price (₹)
Thermal Overload Relay for Mini Contactor	1 NO + 1NC	0.1- 0.16A	851201	1010
Thermal Overload Relay for Mini Contactor	1 NO + 1NC	0.16-0.25A	851202	1010
Thermal Overload Relay for Mini Contactor	1 NO + 1NC	0.25-0.3A	851203	1010
Thermal Overload Relay for Mini Contactor	1 NO + 1NC	0.3-0.54A	851204	1010

— opticon™ — **THERMAL OVERLOAD RELAY**

HSN Code: 8536



Type	Auxiliary Contact	Rating(A)	Cat. Ref	Unit Price (₹)
Thermal Overload Relay for Mini Contactor	1 NO + 1NC	0.54-0.8A	851205	1010
Thermal Overload Relay for Mini Contactor	1 NO + 1NC	0.8-1.2A	851206	1010
Thermal Overload Relay for Mini Contactor	1 NO + 1NC	1.8-2.6A	851208	1010
Thermal Overload Relay for Mini Contactor	1 NO + 1NC	2.6-3.7A	851209	1010
Thermal Overload Relay for Mini Contactor	1 NO + 1NC	3.7-5.5A	851210	1010
Thermal Overload Relay for Mini Contactor	1 NO + 1NC	5.5-8.0A	851211	1010
Thermal Overload Relay for Mini Contactor	1 NO + 1NC	8.0-11.5A	851212	1010
Thermal Overload Relay for Mini Contactor	1 NO + 1NC	9-13A	851213	1104

— opticon™ — **MOTOR PROTECTION CIRCUIT BREAKER - MPCB**

HSN Code: 8536



Thermal Protection Adj. Range	Frame	Contact	Rating(A)	Cat. Ref	Unit Price (₹)
0.1-0.16	1	-	0.16	851221	2366
0.16-0.25	1	-	0.25	851222	2366
0.25-0.4	1	-	0.4	851223	2366
0.4-0.63	1	-	0.63	851224	2580
0.63-1	1	-	1	851225	2580
1-1.6	1	-	1.6	851226	2680
1.6-2.5	1	-	2.5	851227	2680
2.5-4	1	-	4	851228	2744
4-6	1	-	6	851229	2744
6-10	1	-	10	851230	2898
9-14	1	-	14	851231	2898
13-18	1	-	18	851232	3158
17-23	1	-	23	851233	3158
20-25	1	-	25	851234	4022
24-32	1	-	32	851235	4022
25-40	2	-	40	851236	8558
40-63	2	-	63	851237	8558
56-80	2	-	80	851238	10214

— opticon™ — **ACCESSORIES FOR MPCB**

HSN Code: 8538



Type	Contact	Rating	Cat. Ref	Unit Price (₹)
Shunt trip	-	110 - 115 V AC	851261	1530
Shunt trip	-	220 - 240 V AC	851262	1530
Shunt trip	-	380 - 415 V AC	851263	1530
Undervoltage	-	110 - 115 V AC	851264	1530
Undervoltage	-	220 - 240 V AC	851265	1530
Undervoltage	-	380 - 415 V AC	851266	1530
Auxiliary contact Top	1 NO + 1 NC	-	851271	680
Auxiliary contact Top	2 NO	-	851272	680
Auxiliary contact Side (frame-1)	1 NO + 1 NC	-	851273	606
Auxiliary contact Side (frame-1)	2 NO	-	851274	606
Auxiliary Alarm	1 NO + 1NO	-	851275	1158
Auxiliary Alarm	1 NO + 1 NC	-	851276	1158
Auxiliary Alarm	1NC + 1NO	-	851277	1158
Auxiliary Alarm	1 NC + 1 NC	-	851278	1158
Enclosure	-	-	851279	862
Auxiliary contact Side (frame -2)	1 NO + 1 NC	-	851280	680
Auxiliary contact Side (frame -2)	2 NO	-	851281	680

SWITCH DISCONNECTOR FUSES

HSN Code: 8536

Rated Current	Type	IN OPEN EXECUTION*		IN SHEET STEEL ENCLOSURE		Recommended HRC Fuse Indo Asian Make
		Cat Ref.	Unit Price (₹)	Cat Ref.	Unit Price (₹)	
32A BS	TPN	INO1A032	1632	INS1A032	3428	FSA
63A BS	TPN	INO1A063	2278	INS1A063	4292	FSS
100A BS	TPN	INO1A100	5226	INS1A100	7512	FSDCP
125A BS	TPN	INO1A125	6052	INS1A125	8228	FSDCP
160A BS	TPN	INO1A160	6590	INS1A160	9486	FSDCP
200A BS	TPN	INO1A200	7504	INS1A200	10704	FSF
250A BS	TPN	INO1A250	9322	INS1A250	12824	FSF
315A BS	TPN	INO1A315	11806	INS1A315	15904	FSK
400A BS	TPN	INO1A400	14280	INS1A400	18340	FMF
32A BS	TPSN	INO1B032	2318	INS1B032	P.O.R.	FSA
63A BS	TPSN	INO1B063	2834	INS1B063	P.O.R.	FSS
100A BS	TPSN	INO1B100	6134	INS1B100	P.O.R.	FSDCP
125A BS	TPSN	INO1B125	7522	INS1B125	P.O.R.	FSDCP
160A BS	TPSN	INO1B160	8504	INS1B160	P.O.R.	FSDCP
200A BS	TPSN	INO1B200	9076	INS1B200	P.O.R.	FSF
250A BS	TPSN	INO1B250	11344	INS1B250	P.O.R.	FSF
315A BS	TPSN	INO1B315	14524	INS1B315	P.O.R.	FSK
400A BS	TPSN	INO1B400	16704	INS1B400	P.O.R.	FMF

* Price Does Not Include HRC Fuse

HSN Code: 8536

Rated Current	Type	IN OPEN EXECUTION*		IN SHEET STEEL ENCLOSURE		Recommended HRC Fuse Indo Asian Make
		Cat Ref.	Unit Price (₹)	Cat Ref.	Unit Price (₹)	
32A DIN	TPN	IN10A032	1698	IN1SA032	3420	Size 000
63A DIN	TPN	IN10A063	2398	IN1SA063	4294	Size 000
100A DIN	TPN	IN10A100	5434	IN1SA100	7516	Size 00
125A DIN	TPN	IN10A125	6348	IN1SA125	8296	Size 00
160A DIN	TPN	IN10A160	6918	IN1SA160	9516	Size 00
200A DIN	TPN	IN10A200	7860	IN1SA200	10774	Size 01
250A DIN	TPN	IN10A250	9756	IN1SA250	12824	Size 01
315A DIN	TPN	IN10A315	12928	IN1SA315	16204	Size 02
400A DIN	TPN	IN10A400	15566	IN1SA400	18682	Size 02
630A DIN	TPN	IN10A630	25254	IN1SA630	30576	Size 03
800A DIN	TPN	IN10A800	31438	IN1SA800	P.O.R.	Size 03
32A DIN	TPSN	IN10B032	2412	IN1SB032	P.O.R.	Size 000
63A DIN	TPSN	IN10B063	2946	IN1SB063	P.O.R.	Size 000
100A DIN	TPSN	IN10B100	6538	IN1SB100	P.O.R.	Size 00
125A DIN	TPSN	IN10B125	7820	IN1SB125	P.O.R.	Size 00
160A DIN	TPSN	IN10B160	8914	IN1SB160	P.O.R.	Size 00
200A DIN	TPSN	IN10B200	9680	IN1SB200	P.O.R.	Size 01
250A DIN	TPSN	IN10B250	11864	IN1SB250	P.O.R.	Size 01
315A DIN	TPSN	IN10B315	15676	IN1SB315	P.O.R.	Size 02
400A DIN	TPSN	IN10B400	18030	IN1SB400	P.O.R.	Size 02
630A DIN	TPSN	IN10B630	27272	IN1SB630	P.O.R.	Size 03
800A DIN	TPSN	IN10B800	33940	IN1SB800	P.O.R.	Size 03

* Price Does Not Include HRC Fuse

SWITCH DISCONNECTOR 4 POLE

HSN Code: 8536

Rated Current	IN OPEN EXECUTION*		IN SHEET STEEL ENCLOSURE	
	Cat Ref.	Unit Price (₹)	Cat Ref.	Unit Price (₹)
63A	IN1SD063	2210	IN1ED063	3002
100A	IN1SD100	4092	IN1ED100	6072
125A	IN1SD125	5422	IN1ED125	6730
200A	IN1SD200	7062	IN2ED200	14366
250A	IN1SD250	8490	IN2ED250	15152
315A	IN1SD315	11728	IN3ED315	15544
400A	IN1SD400	15130	IN3ED400	17506
630A	IN1SD630	18030	IN4ED630	20868
800A	IN1SD800	24144	IN4ED800	28542

**Ambidex CHANGEOVER SWITCHES
ON-LOAD CHANGEOVER SWITCHES 4 POLE**

HSN Code: 8536

Rated Current	IN OPEN EXECUTION		IN SHEET STEEL ENCLOSURE	
	Cat Ref.	Unit Price (₹)	Cat Ref.	Unit Price (₹)
63A	ITAE0063	4892	ITAS0063	6656
100A	ITAE0100	6546	ITAS0100	8848
125A	ICAE0125	9954	ICAS0125	13382
160A	ICAE0160	10964	ICAS0160	15192
200A	ICAE0200	13142	ICAS0200	16928
250A	ICAE0250	19506	ICAS0250	23770
320A	ICAE0320	20814	ICAS0320	25850
400A	ICAE0400	30368	ICAS0400	38248
630A	ICAE0630	35850	ICAS0630	43626
800A	ITAE0800	53090	ITAS0800	64464
1000A	ITAE1000	87436	ITAS1000	111222
1250A	ITAE1250	125342	ITAS1250	151630
1600A	ITAE1600	178708	ITAS1600	199430
2000A	ITAE2000	217004	ITAS2000	276230
2500A	ITAE2500	287918	ITAS2500	348006
3150A	ITAE3150	P. O. R.	ITAS3150	470780

HSN Code: 8536

ACCESSORIES FOR AMBIDEX CHANGEOVER SWITCHES	Cat Ref.	Unit Price (₹)
Auxiliary Switch 200A-630A (1NO + 1NC)	ICA00AUX	150
Spreader Links for Frame00 - 1 set (4 links)	ICA00SPL	324

ON-LOAD SWITCH FUSE CHANGEOVER

HSN Code: 8536

Rated Current	IN OPEN EXECUTION		IN SHEET STEEL ENCLOSURE		Recommended HRC Fuse Indo Asian Make
	Cat Ref.	Unit Price (₹)	Cat Ref.	Unit Price (₹)	
125A	ITBE0125	13446	ITBS0125	17630	FSDCP
200A	ITBE0200	24126	ITBS0200	31154	FSF
250A	ITBE0250	24676	ITBS0250	32092	FSK
320A	ITBE0320	25572	ITBS0320	33898	FSK
400A	ITBE0400	36384	ITBS0400	48810	FTS
630A	ITBE0630	41392	ITBS0630	56676	FTS

Price does not include HRC Fuses.

HSN Code: 8536

ON-LOAD BY-PASS SWITCHES

Rated Current	IN OPEN EXECUTION		IN SHEET STEEL ENCLOSURE	
	Cat Ref.	Unit Price (₹)	Cat Ref.	Unit Price (₹)
125A	ITCE0125	15364	ITCS0125	21216
200A	ITCE0200	20060	ITCS0200	25516
250A	ITCE0250	27804	ITCS0250	36608
320A	ITCE0320	29768	ITCS0320	37604
400A	ITCE0400	45610	ITCS0400	54116
630A	ITCE0630	51440	ITCS0630	63112

HRC FUSE LINKS & BASES

BOLTED TYPE (BS) BREAKING CAPACITY ≥ 80kA 500 V AC 50 Hz.

HSN Code: 8536

Rating	Type	Cat Ref.	Tag Type	Unit Price (₹)	Unit/Carton
2, 4, 6, 10, 16A	FGN	IEFGN***	Offset	56	20
20, 25, 32A	FGN	IEFGN***	Offset	62	20
6, 10, 16, 20, 25, 32A	FSA	IEFSA***	Offset	86	10
35, 40, 50, 63A	FSS	IEFSS***	Offset	98	10
50, 63, 80, 100, 125, 160A	FSDCP	IEDCP***	Offset	206	10
125, 160, 200A	FSFP	IESFP***	Offset	296	3
50, 63, 80, 100, 125A	FSDC	IESDC***	Central	206	10
125, 160, 200, 250A	FSF	IEFSF***	Central	302	3
250, 300, 315A	FSK	IEFSK***	Central	438	3
355, 400A	FMF	IEFMF***	Central	846	3
400, 500, 630A	FTS	IEFTS***	Central	974	1
400, 500A	FTM	IEFTM***	2 Central	1270	1
630A	FTM	IEFTM***	2 Central	1732	1

DIN TYPE BREAKING CAPACITY ≥ 80kA 500 V AC 50 Hz.

HSN Code: 8536

Rating Amps	Type	Cat Ref.	Unit Price (₹)	Unit/Carton
6, 10, 16, 20, 25, 32, 50, 63A	Size 000	IWS00***	256	6
6, 10, 16, 20, 25, 32, 50, 63A	Size 00	IW000***	274	6
80, 100A		IW000***	286	6
125, 160A		IW000***	304	6
32, 63, 80, 100, 125, 160, 200A	Size 01	IW001***	502	3
250A		IW001***	570	3
250, 315A	Size 02	IW002***	738	3
400A		IW002***	798	3
315, 425A	Size 03	IW003***	1012	3
500, 630A		IW003***	1178	3

* Note HRC fuses with SC breaking capacity 120kA are available on request.

CYLINDRICAL TYPE (IFRH) BREAKING CAPACITY > 80kA 415 V AC.

HSN Code: 8536

Rating	Cat Ref.	Unit Price (₹)
2 to 25A	IFRHO***	108
32 to 40A	IFRHO***	116
50A	IFRHO050	212
63A	IFRHO063	218
Fuse Holder Fr type (2 to 63A)	IFRO0***	202

FUSE FITTINGS FOR BOLTED (BS) TYPE / DIN TYPE HRC FUSE LINKS

HSN Code: 8536

Rating	Front Connection	Unit Price (₹)	Back Busbar Connection	Unit Price (₹)	Unit/Carton
20A	BFFC 0020	124	BFBC 0020	134	10
32A	BFFC 0032	216	BFBC 0032	226	10
63A	BFFC 0063	312	BFBC 0063	328	5
100A	BFFC 0100	802	BFBC 0100	826	3
20A (Stud Type)			BFFCS 020	178	1

FUSE BASES FOR DIN TYPE HRC FUSE LINKS

HSN Code: 8536

Rating Amps	Suitable for	Cat Ref.	Unit Price (₹)	Unit/Carton
6-160A	Size - 00	IWFB0***	350	6
32-250A	Size - 1	IWFB1***	672	2
100-400A	Size - 2	IWFB2***	1006	2
315-630A	Size - 3	IWFB3***	1276	2

REWIRABLE SWITCH FUSE UNIT

HSN Code: 8537

 <ul style="list-style-type: none"> • Single Pole & Neutral/Double Pole 240/415 VAC 50 Hz • Conforms to IS/IEC 13947-3 	Rating	Type	Cat Ref.	Rated Voltage	Unit Price* (₹)
	16A	SPN	RCSPN016	240 V	590
	32A	SPN	RCSPN032	240 V	1458
	16A	DP	RCDP0016	240 V	608
	32A	DP	RCDP0032	240 V	1590
	32A	DP	#DDP0032	415 V	2056
63A	DP	#DDP0063	415 V	4098	

For Rewirable type carrier, prefix R, for HRC type carrier, prefix H.
* These prices are without wire & HRC.

COMBINATION FUSE SWITCH

HSN Code: 8536

 <ul style="list-style-type: none"> • Double Break in Sheet steel enclosure • Conforms to IS/IEC 13947-3 • Rated Voltage - 415V AC 50 Hz • Type - TPN 	Rating	HRC Fuse Type	Cat Ref.	Unit Price* (₹)
	63A	FSS	DDTPN063	7230
	100A	FSDCP	DDTPN100	9708
	200A	FSF	DDTPN200	14450
	300A	FSK	DDTPN300	18234
400A	FTS	DDTPN400	26712	

* These prices are without HRC.

**TRIPLE POLE NEUTRAL HRC TYPE
REWIRABLE SWITCH FUSE UNIT**

**HSN Code: 8537 H
HSN Code: 8536 R**

 <ul style="list-style-type: none"> • Rated Voltage - 415V-AC 50Hz • Type - TPN 	Rating	HRC Fuse Type	Cat Ref.	Unit Price* (₹)
	16A	FSA	#DTPN016	1774
	32A	FSA	#DTPN032	2388
	63A	FSS	#DTPN063	5086
100A	FSDCP	#DTPN100	9272	

For Rewirable type carrier, prefix R, for HRC type carrier, prefix H.
* These prices are without wire & HRC.

OFF LOAD CHANGEOVER SWITCH

HSN Code: 8536

 <ul style="list-style-type: none"> • With enclosure • Rated Voltage - 415V-AC 50Hz • Type - FP 	Rating	Cat Ref.	Unit Price (₹)
	32A (DP)	OFDP0032	1692
	16A	OFFP0016	2654
	32A	OFFP0032	3138
	63A	OFFP0063	6272
	100A	OFFP0100	12632
	125A	OFFP0125	13524
	200A	OFFP0200	18608
	250A	OFFP0250	19318
	315A	OFFP0315	24052
400A	OFFP0400	32070	

Prices for spares of Rewirable Switch Fuse Unit like Action Bar, Base Plate, End Shield, Bakelite Contact Shrouds are available on request.

**HEAVY ON
QUALITY**



**LIGHT ON
POCKET**

Presenting Glint.

Quality modular switches at an affordable price.



GlintTM
Welcome Change

Glint™ SWITCH / SWITCH WITH INDICATOR

- Polycarbonate Material • LED Indicator • ISI Marked

HSN Code: 8536

Image	Description	Module	Pack	Cat. Nos.	Unit Price (₹)
		6A 1-way Switch	1	1/10/200	800000
6A 2-way Switch		1	1/10/200	800001	48
16A 1-way Switch		1	1/10/100	800002	66
16A 2-way Switch		1	1/10/100	800003	78
16A 1-way Switch with Indicator		1	1/10/100	800004	76
20A DP Switch		2	1/10/50	800005	96
32A DP Switch		2	1/10/50	800006	142
6A Bell Push with Indicator-1M		1	1/10/100	800007	54
6A Bell Push with Indicator-2M		2	1/10/100	800008	84

Glint™ SOCKET / TELEPHONE SOCKET / COMPUTER SOCKET / TV SOCKET

- Pencil Free Operation • Child Safety Shutter
- Accommodate Wide Range of 2 Pin Round and Flat Pin Plugs

HSN Code: 8536

Image	Description	Module	Pack	Cat. Nos.	Unit Price (₹)
		6A 3 Pin Universal Socket	2	1/10/100	800020
10A Euro US Socket		1	1/20/100	800021	48
6/16A 3 Pin Socket		2	1/10/50	800022	92
Multistandard Socket 6/10/13A-250V, 15A-127V		2	1/10/100	800023	88
Telephone Socket - RJ11		1	1/20/100	800030	54
Computer Socket - RJ45		1	1/20/100	800031	122
TV Socket		1	1/20/100	800032	48

Glint™ BUZZER / FAN STEP REGULATOR / POWER UNIT

- Fan Marking for Easy Identification
- Power Unit - Prewired, Suitable for 2 Ton Ac / 3.5 kw Geyser

HSN Code: 8536

Image	Description	Module	Pack	Cat. Nos.	Unit Price (₹)
		Buzzer - 230V	1	1/20/100	800040
Fan Step Regulator - 100W		1	1/10/100	800041	234
Fan Step Regulator - 100W - 2M		2	1/10/100	800043	264
16A Power Unit for AC & Geyser		4	1/1/5	800025	234
Flat Indicator Red		1	1/10/100	800033	66

Glint™ LIGHT DIMMER

- Marking for Easy Identification

HSN Code: 8538

Image	Description	Module	Pack	Cat. Nos.	Unit Price (₹)
		Light Dimmer - 400W	1	1/10/100	800042

Glint™ BLANK PLATE / SCREW CAPS

- Spare Screw Caps Available

HSN Code: 8538

Image	Description	Module	Pack	Cat. Nos.	Unit Price (₹)
		1 Module Blank Plate	1	1/20/200	800051
2 Module Blank Plate		2	1/10/100	800052	20
Screw Caps		-	1/10/100	800059	18*

* One Unit Contains Ten Pieces of Screw Caps

Glint™ MODULAR PLATES - WHITE COLOUR

- Unique Design - Sleek & Curvy • Flame Retardant Material • Compatible with all Standard Size Metal Flush & Plastic Surface Boxes

HSN Code: 8538

	Description	Module	Pack	Cat. Nos.	Unit Price (₹)
	1 Module Plate	1	1/10/100	800061	32
	2 Module Plate	2	1/10/100	800062	32
	3 Module Plate	3	1/10/100	800063	42
	4 Module Plate	4	1/10/100	800064	54
	6 Module Plate	6	1/5/50	800066	66
	8 Module Plate (Vertical)	8	1/5/25	800067	96
	8 Module Plate (Horizontal)	8	1/5/50	800068	86
	12 Module Plate	12	1/5/25	800065	118
	16 Module Plate	16	1/5/25	800069	124
18 Module Plate	18	1/5/25	800070	148	

Glint™ METAL FLUSH BOX

- Made of G.I. Sheet • Earth Terminal for Safety

HSN Code: 8538

	Description	Module	Pack	Cat. Nos.	Unit Price (₹)
	Metal Flush Box - 1 / 2 Module	1 / 2	1/0/40	800172	38
	Metal Flush Box - 3 Module	3	1/0/40	800173	52
	Metal Flush Box - 4 Module	4	1/0/40	800174	64
	Metal Flush Box - 6 Module	6	1/0/40	800176	102
	Metal Flush Box - 8 Module(V)	8	1/0/20	800177	130
	Metal Flush Box - 8 Module(H)	8	1/0/40	800178	130
	Metal Flush Box - 12 Module	12	1/0/10	800175	174
	Metal Flush Box - 16 Module	16	1/0/10	800179	200
	Metal Flush Box - 18 Module	18	1/0/10	800180	214

Glint™ SURFACE BOX

- Flame Retardant Material • Edge to Edge Fitting with Glint Plate

HSN Code: 8538

	Description	Module	Pack	Cat. Nos.	Unit Price (₹)
	Plastic Surface Box 1/2 Module	1 / 2	1/0/50	800182	46
	Plastic Surface Box - 3 Module	3	1/0/35	800183	58
	Plastic Surface Box - 4 Module	4	1/0/25	800184	66
	Plastic Surface Box - 6 Module	6	1/0/10	800186	102
	Plastic Surface Box - 8 Module (V)	8	1/0/15	800187	146
	Plastic Surface Box - 8 Module (H)	8	1/0/10	800188	142
	Plastic Surface Box - 12 Module	12	1/0/10	800185	174
	Plastic Surface Box - 16 Module	16	1/0/10	800189	208
	Metal Surface Box - 18 Module	18	1/0/10	800190	220

Modular switches, while being flexible and good looking save more than half of your installation time. The Glint modular range is very easy to install. With just a simple mechanism they'll adorn your walls even before you know it.

Insert and press mechanism in the modular plate.
No tools required.

Glint™
Welcome Change

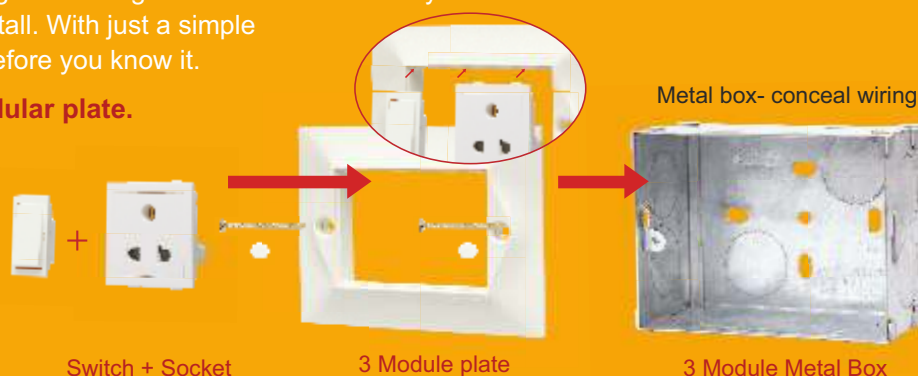

Switch + Socket

3 Module plate

3 Module Metal Box

Cover Plates - Glint™

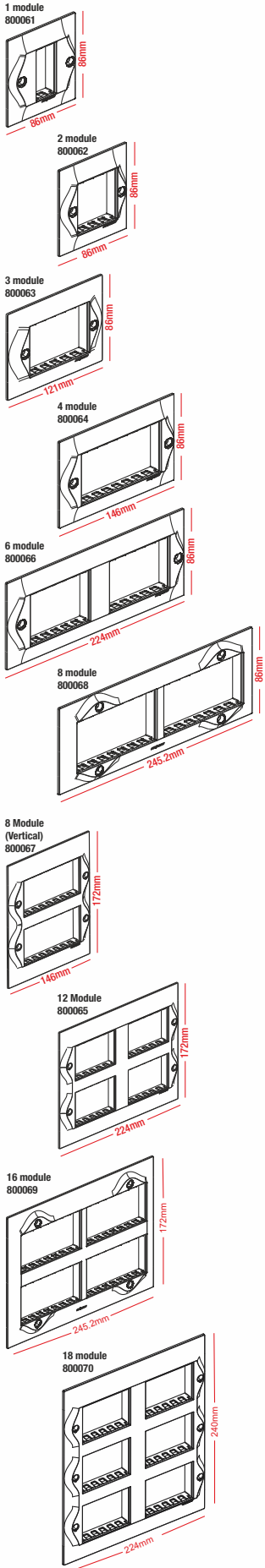

Flush Boxes-Metal

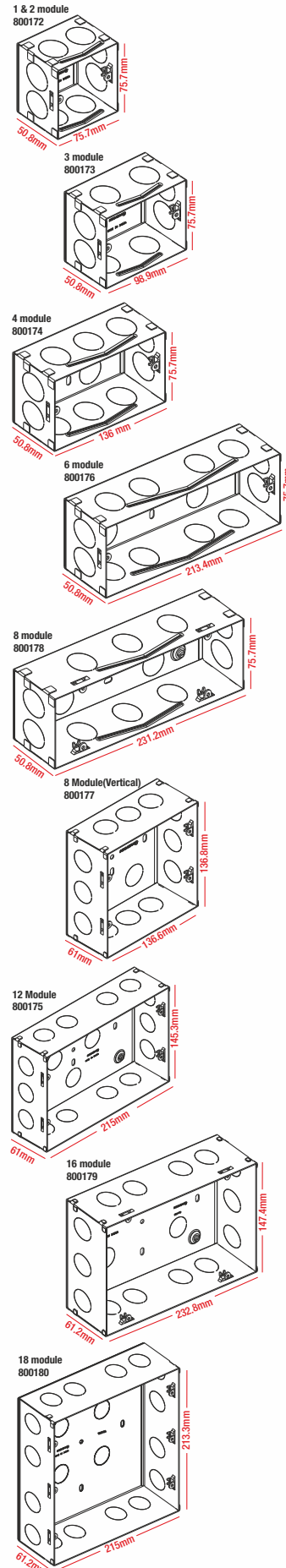

Surface Boxes

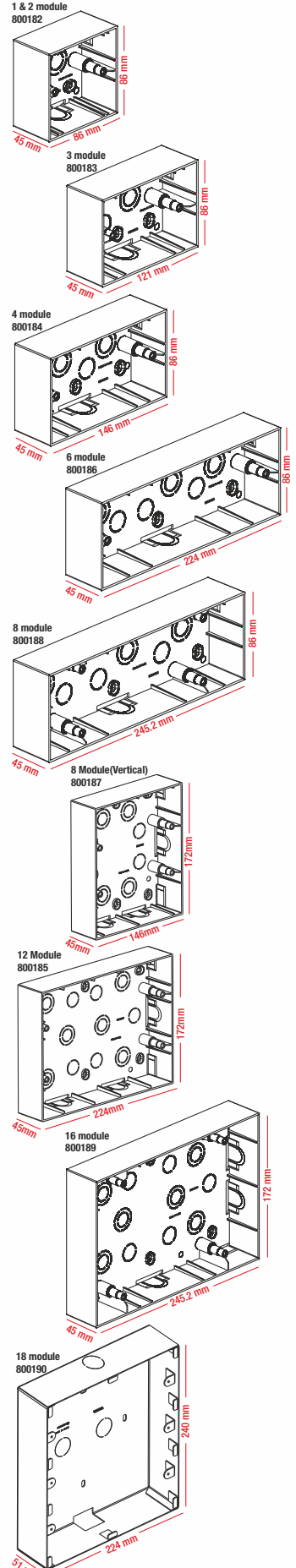

WE THINK
YOU LIVE
BETTER
BETTER

ELVIRA
A SENSIBLE SWITCH



ELVIRA SWITCH / SWITCH WITH INDICATOR

A SENSIBLE SWITCH

• Polycarbonate Material • LED Based Indicator • Shrouded Terminal • ISI Marked

HSN Code: 8536

Description	Module	Pack	Cat. Nos.	Unit Price (₹)	
				Module	Pack
6A 1 way Switch	1	1/20/200	800100	32	
6A 2 way Switch	1	1/20/100	800101	60	
6A 1 way Switch with Indicator	1	1/20/200	800102	62	
16A 1 way Switch	1	1/20/200	800103	82	
16A 2 way Switch	1	1/10/100	800104	102	
16A 1way Switch with indicator	1	1/20/200	800105	90	
25A 1 way Switch with indicator	1	1/10/100	800106	128	
20A DP Switch	2	1/10/50	800107	124	
32A DP Switch	2	1/10/50	800108	174	
6A Bell Push with indicator - 1M	1	1/20/200	800110	66	
6A Bell Push with indicator - 2M	2	1/10/100	800111	102	

ELVIRA SOCKET

A SENSIBLE SWITCH

• Child Safety Shutter • Shrouded Terminals • Compatible with all standard Mobile chargers

HSN Code: 8536

Description	Module	Pack	Cat. Nos.	Unit Price (₹)	
				Module	Pack
6A 3 Pin Universal Socket	2	1/10/100	800120	62	
10A Euro US Socket	1	1/20/100	800121	60	
6/16A 3 Pin Socket	2	1/10/50	800122	114	
25A 3 Pin Socket	2	1/10/50	800124	124	
Multistandard Socket 6/10/13A-250v	2	1/10/100	800123	102	

ELVIRA RJ11 / RJ45 / TV SOCKET

A SENSIBLE SWITCH

Tool less, Twisted operation Computer Socket/RJ45

HSN Code: 8536

Description	Module	Pack	Cat. Nos.	Unit Price (₹)	
				Module	Pack
Telephone Socket - RJ11	1	1/20/100	800130	60	
Computer Socket - RJ45 Cat 6	1	1/20/100	800131	172	
TV Socket	1	1/20/100	800132	56	

ELVIRA FAN REGULATOR / POWER UNIT / CONTROL PRODUCTS / MINI MCB

A SENSIBLE SWITCH

• Laser marking • LED Indicator • Pre-Wired Power Unit

HSN Code: 8536

Description	Module	Pack	Cat. Nos.	Unit Price (₹)	
				Module	Pack
Buzzer 230V	1	1/20/100	800140	180	
Fan Step Regulator 100W - 1M	1	1/10/100	800141	258	
Fan Step Regulator 100W - 2M	2	1/10/100	800142	316	
16A Power unit for AC & Geyser	4	1/1/5	800125	258	
Bell Call Indicator	1	1/20/100	800144	386	
Flat Indicator Red	1	1/20/100	800154	78	
Skirting light - 2M	2	1/5/25	800155	266	
25A Motor Starter	2	1/10/50	800196	302	
16A Mini MCB SP C curve	1	1/10/100	800160	278	
20A Mini MCB SP C curve	1	1/10/100	800191	278	

ELVIRA LIGHT DIMMER

A SENSIBLE SWITCH

• Laser marking

HSN Code: 8538

Description	Module	Pack	Cat. Nos.	Unit Price (₹)	
				Module	Pack
Light Dimmer 400W	1	1/10/100	800143	256	

ELVIRA BLANK PLATES / CABLE OUTLET

A SENSIBLE SWITCH

• Polycarbonate Material

HSN Code: 8538

	Description	Module	Pack	Cat. Nos.	Unit Price (₹)
	1 module Blank	1	1/20/200	800151	18
2 module Blank	2	1/10/100	800152	28	
Cable outlet	1	1/20/100	800153	54	

ELVIRA MODULAR PLATE WITH SUPPORT FRAME - WHITE

A SENSIBLE SWITCH

• Strong Dimensional Stability

HSN Code: 8538

	Description	Module	Pack	Cat. Nos.	Unit Price (₹)
	1 Module Plate	1	1/10/100	800161	42
2 Module Plate	2	1/10/100	800162	42	
3 Module Plate	3	1/10/100	800163	56	
4 Module Plate	4	1/10/100	800164	60	
6 Module Plate	6	1/5/50	800166	82	
8 Module Plate (Horizontal)	8	1/5/50	800168	108	
8 Module Plate (Vertical)	8	1/5/25	800167	110	
12 Module Plate	12	1/5/25	800165	156	
16 Module Plate	16	1/5/25	800169	176	
18 Module Plate	18	1/5/25	800170	212	

ELVIRA METAL FLUSH BOX

A SENSIBLE SWITCH

• Made of G.I. Sheet • Earth Terminal for Safety

HSN Code: 8538

	Description	Module	Pack	Cat. Nos.	Unit Price (₹)
	Metal Flush Box - 1 / 2 Module	1 / 2	1/0/40	800172	38
Metal Flush Box - 3 Module	3	1/0/40	800173	52	
Metal Flush Box - 4 Module	4	1/0/40	800174	64	
Metal Flush Box - 6 Module	6	1/0/40	800176	102	
Metal Flush Box - 8 Module(V)	8	1/0/20	800177	130	
Metal Flush Box - 8 Module(H)	8	1/0/40	800178	130	
Metal Flush Box - 12 Module	12	1/0/10	800175	174	
Metal Flush Box - 16 Module	16	1/0/10	800179	200	
Metal Flush Box - 18 Module	18	1/0/10	800180	214	

ELVIRA SURFACE BOX

A SENSIBLE SWITCH

• Flame Retardant Material • Edge to Edge Fitting with Plate

HSN Code: 8538

	Description	Module	Pack	Cat. Nos.	Unit Price (₹)
	Plastic Surface Box 1/2 Module	1 / 2	1/0/50	800182	46
Plastic Surface Box - 3 Module	3	1/0/35	800183	58	
Plastic Surface Box - 4 Module	4	1/0/25	800184	66	
Plastic Surface Box - 6 Module	6	1/0/10	800186	102	
Plastic Surface Box - 8 Module (V)	8	1/0/15	800187	146	
Plastic Surface Box - 8 Module (H)	8	1/0/10	800188	142	
Plastic Surface Box - 12 Module	12	1/0/10	800185	174	
Plastic Surface Box - 16 Module	16	1/0/10	800189	208	
Metal Surface Box - 18 Module	18	1/0/10	800190	220	

Cover Plates - ELVIRA
A SENSIBLE SWITCH

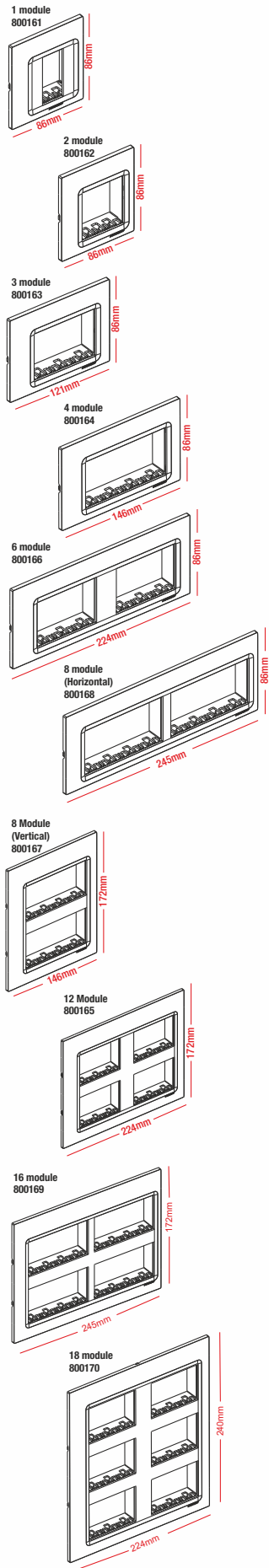

Flush Boxes-Metal

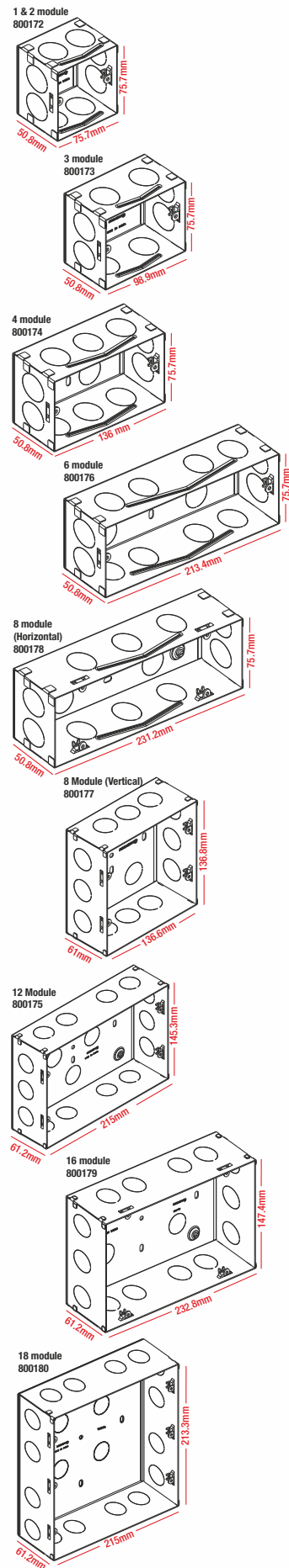

Surface Boxes

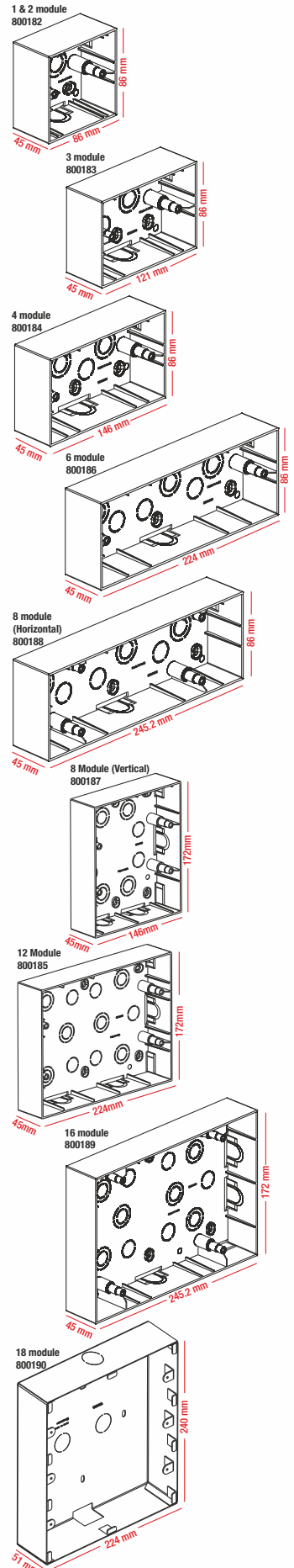

GENERAL TERMS

- This price list supersedes all previous price lists.
- All prices are in Indian Rupees only.
- All prices are Maximum Retail Prices (MRP) inclusive of GST as applicable.
- Our discount structure is exclusive of GST
- Orders will be accepted in multiples of standard packing.
- Prices are subject to change without notice. All despatches will be as per prices prevailing on the date of despatch. Prices are ex-godown, exclusive of packing/forwarding/freight and insurance.
- Product design is subject to change without notice for continuous up gradation.
- Disputes if any are subject to Delhi Jurisdiction only.
- Company reserves the right to issue amendments which may arise due to any printing errors in the price list.

WARRANTY

IA products carry a warranty against manufacturing defects, subject to use of the product for the right application, with correct wiring/connection and normal operating conditions. Please refer to detailed Indo Asian warranty policy effective 1st Jan 2016.

MCBs	36 Months
RCCBs	18 Months
DBs	12 Months
Rewirable/HRC Fuses	6 Months
MCCBs/BFF/Fuse Bases/Changeover Switchgears/SDF	12 Months
Time Switches	12 Months
Contactors/Overload Relay/MPCBs	12 Months
For Wiring Devices - Switches & Socket	120 Months
For Wiring Devices - Electronic Products (e.g. Fan Regulator, Dimmer, Buzzer, RJ45, RJ11 & TV Sockets, Bell Indicator, Motor starter, Skirting light)	24 Months

CHANNEL PARTNER

CORPORATE OFFICE: V. J. Business Towers, A-6, 1st Floor, Sector-125, Noida-201301, U.P., India. Ph.: +91-0120-3305100 E-mail: sales@indoasian.com, international@indoasian.com Website: www.indoasian.com

CUSTOMER CARE SUPPORT EXECUTIVE: V. J. Business Towers, A-6, 1st Floor, Sector-125, Noida-201301, U.P., India. Ph.: +91-0120-3305111 E-mail: feedback@indoasian.com

NORTH

Regional Sales office DELHI NCR

V. J. Business Towers
A-6, Ground Floor,
Sector-125, Noida-201301
Ph.: 0120-3365300
E-Mail: in-delhi-office@indoasian.com

Branch office CHANDIGARH

S.C.O.-11, 2nd Floor,
Sector-26, Madhya Marg,
Chandigarh-160002
Ph.: 0172-3934651
E-Mail: in-chandigarh-office@indoasian.com

Branch office JAIPUR

433, 4th Floor, Ganpati Plaza,
M. I. Road,
Jaipur-302001
Ph.: 0141-4113528
E-Mail: in-jaipur-office@indoasian.com

Branch office LUCKNOW

301, 3rd Floor, Chintel House,
Station Road,
Lucknow-226001
Ph.: 0522-4013210
E-Mail: in-lucknow-office@indoasian.com

SOUTH

Regional Sales office BANGALORE

787, 1st Floor "Skyline Vista"
15th Cross, 100 Feet Ring Road
J P Nagar 1st Phase
Bangalore-560 078
Tel: 080-46219999
E-Mail: in-bangalore-office@indoasian.com

Branch office COCHIN

Door No.65/1317, Syda Building,
2nd Floor, Kaloor-Kadavanthra Road,
Kaloor, Emakulam District,
Kochi-682017 (Kerala)
Ph.: 0484-4055581-88
E-Mail: in-cochin-office@indoasian.com

Branch office COIMBATORE

Door No. 83,
Dr. Nanjappa Road,
Coimbatore-641018
Ph.: 0422-2302715
E-Mail: in-coimbatore-office@indoasian.com

Branch office CHENNAI

No.5, 1st Floor, Mahalingapuram Main Road,
Nungambakkam,
Chennai-600034
Ph.: 044-28172096, 28170527
E-Mail: in-chennai-office@indoasian.com

Branch office HYDERABAD

312, 3rd Floor,
Amrutha Estates, Himayath Nagar,
Hyderabad-500029
Ph.: 040-66742425
E-Mail: in-secunderabad-office@indoasian.com

WEST

Regional Sales office MUMBAI

401 & 408, K.P. Arrum,
Marol Morshi Road, Andheri East,
Mumbai-400059
Ph.: 022-61035800
E-Mail: in-mumbai-office@indoasian.com

Branch office AHMEDABAD

102, 1st Floor, Shivalik High Street,
Near Mansi Circle, Vastrapur,
Ahmedabad-380015
Ph.: 079-29701351-53
E-Mail: in-ahmedabad-office@indoasian.com

Branch office INDORE

202, KK Bafna Arcade,
Janjeerwala Square,
Race Course Road,
Indore-452001
Ph.: 0731-4064064
E-Mail: in-indore-office@indoasian.com

Branch office PUNE

1307, 4th Floor, Rajadwar Building,
Off. J. M. Road, Shivaji Nagar,
Pune-411005
Ph.: 020-60500440
E-Mail: in-pune-office@indoasian.com

EAST

Regional Sales office KOLKATA

"Raikva Building" Room No. 8, 2nd Floor,
3A Ram Mohan Garden Lane,
Beliaghata E.M.Bypass, Kolkata-700010
Ph.: 033-66041503
E-Mail: in-kolkata-office@indoasian.com